

# FT-203R INSTRUCTION MANUAL

SCHEMATHEEK  
Beh. T. Hultermans  
Postbus 4228  
5604 EE Eindhoven

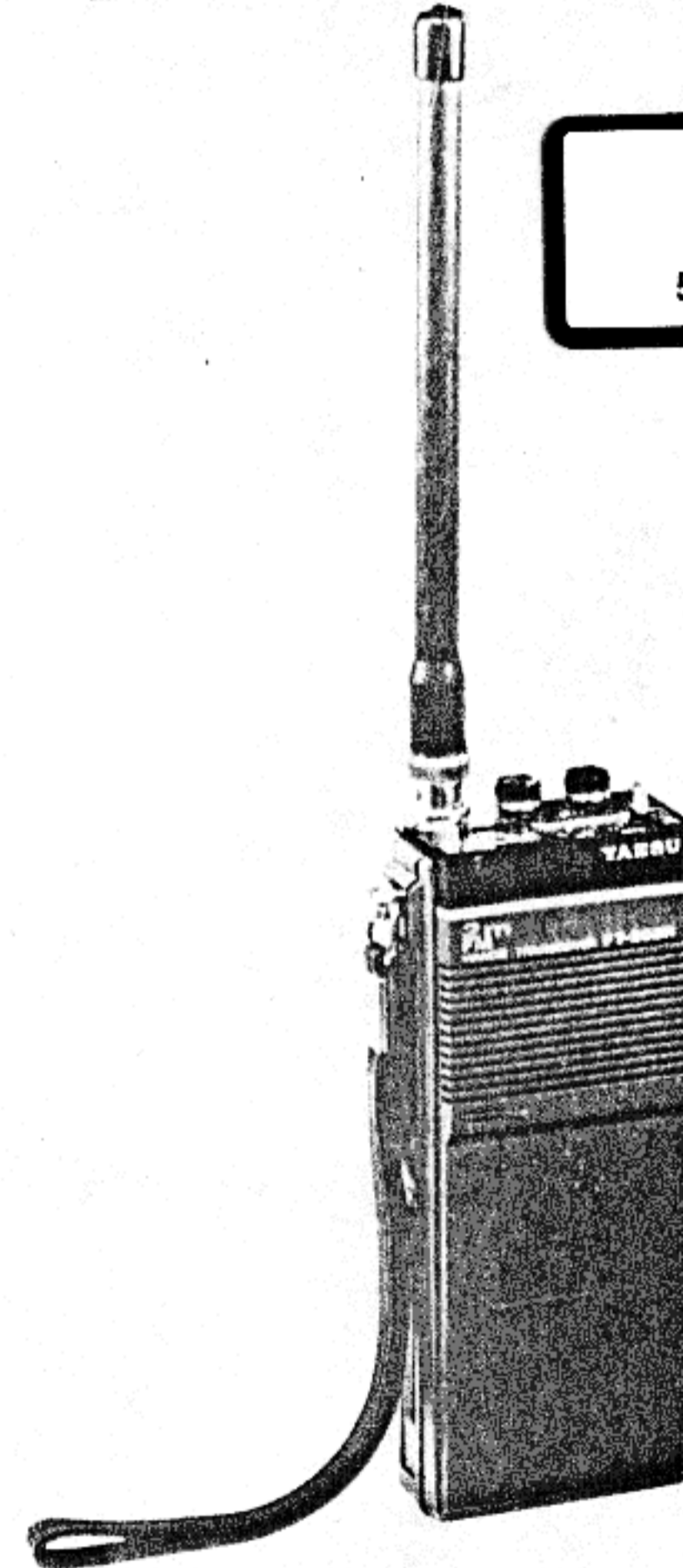

YAESU MUSEN CO., LTD.  
C.P.O. BOX 1500  
TOKYO, JAPAN



Power source options include the FNB-3 10.8V 425 mAh Ni-Cd battery pack or the FBA-5 battery case for six AA-size dry cells. Chargers available include the NC-9B/C 15-hour wall charger, NC-15 1-hour quick or trickle charger and the PA-3 DC-DC mobile adapter.

Please read this manual carefully so as to become acquainted with the convenient features of the FT-203R.

## SPECIFICATIONS

### GENERAL

Freq. range:  
144-146 or 144-148 MHz (per local requirements)

Channel steps:  
10 kHz, and +5 kHz switch

Mode:  
F3 (G3E)

Antenna:  
BNC connector, rubber flex antenna supplied

Supply voltage:  
5.5-13V DC

Current:  
RX 100 mA; Standby 20 mA;  
TX 700 mA (@ 10.8V, 2.5W RF)

Case size:  
65 (W) x 34 (D) x 153 (H) mm

Weight:  
Approx. 450g w/FNB-3

Audio output:  
450 mW into 8 ohms for 10% THD, or better

### TRANSMITTER (@ 10.8V)

Input power:  
5W DC for 2.5W RF output into 50 ohms

Modulation:  
Variable reactance

Deviation:  
±5 kHz

Max. bandwidth:  
16 kHz

Microphone:  
Internal or optional external condenser, 2 kilohms

Specification subject to change without notice or obligation

### RECEIVER (@ 10.8V)

Circuit type:  
Double conversion superheterodyne

First IF:  
10.695 MHz

Second IF:  
455 kHz

Sensitivity:  
0.25 µV for 12 dB SINAD,  
1 µV for 30 dB S/N

Selectivity:  
±6 kHz/-6 dB, ±12 kHz/-60 dB

### MODEL CHART\*

Model	A	D	E	F
Frequency (MHz)	144-148	144-146	144-148	144-146
Tone Burst	not available	1750 Hz	1750 Hz	not available
Tone Squelch	option	not available	not available	option

\* Repeater Shift is ±600 kHz for all models (exc JA).  
DTMF keypad available as an option for all models.  
Model F is for use in Japan only, and cannot be readily converted to other models.

## SEMICONDUCTORS

### ICs:

LA4145 1  
LA6324M 1  
MC3357P 1  
TC5081AP 1  
TC5082P 1  
TC5082PL 1  
TC9122P 1

### TRANSISTORS:

2SA1162GR(SG) 7  
2SB793R 2  
2SC2053 1  
2SC2196 1  
2SC2620B(QB) 10  
2SC2712GR(LG) 12  
2SC3120(HB) 2  
2SD1366(AB) 1

### FETs:

2SK2080(JO) 1  
2SK210Y(YY) 1

### LEDs:

LN38GCP 1  
LN28RCP 1

### DIODES:

Si 1S1555 1  
1SS184(B3)4  
1SS205 14  
Schottky  
1SS106 2  
Varactor  
1SV69 4  
1T32 3  
FC53M-5 1  
Zener HZ6A1L 1  
HZ9B2L 1

## SUPPLIED ACCESSORIES

FNB-3  
10.8V, 425 mAh Ni-Cd pack

CSC-6  
Soft Case

FTE-2 (European models only)  
1750 Hz Tone Burst Unit

YHA-14A  
Helical Rubber Antenna

## OPTIONS

FBA-5  
Battery Case for 6 AA-size dry cells

YH-2  
Headset

MH-12A2B  
Speaker/Microphone

FTS-7 (for Model A only)  
Programmable Tone Squelch

PA-3  
DC Car Adapter/Trickle Charger

MMB-21  
Mobile Hanger Bracket

NC-9B\*  
Compact Charger 117 VAC

NC-9C\*  
Compact Charger 220 VAC

NC-15  
Quick Charger/DC Adapter

\* for FNB-3 only

## CONTROLS AND CONNECTIONS

### ① Antenna Jack

This BNC-type jack accepts the YHA-14A rubber flex antenna, or another antenna or feedline with an impedance of 50 ohms at the operating frequency. Do not transmit without having an antenna connected here.

### ② SQL/TONE

This squelch control sets the receiving threshold level, below which noise and (weak) signals will be silenced. Turn this control clockwise to raise the threshold and decrease sensitivity.

When the optional FTS-7 subaudible tone squelch encoder/decoder is installed in the transceiver\*, setting the SQL control fully counterclockwise into the TONE click-stop will activate the FTS-7, thus silencing the receiver to all signals that do not carry the programmed subaudible tone.

\* not available for (European) versions having Tone Burst.

### ③ VOL/OFF

When this control is set into the click-stop, the transceiver is switched OFF. During operation, this control sets the volume of the receiver in the internal or external speaker or earphone.

### ④ +5 kHz

Press this button to add five kilohertz to the operating frequency (both transmit and receive), for operation on channels that are odd multiples of 5 kHz.

### ⑤ EAR and MIC jacks

These two jacks are both used by the optional YH-2 Headset or MH-12A2B Handy Speaker/Microphone. Except when using the YH-2, an optional earphone may be connected to the EAR jack, either directly or through the MH-12A2B plug. The corresponding microphone and speaker within the transceiver are disabled when connections are made to the respective MIC and EAR jacks.

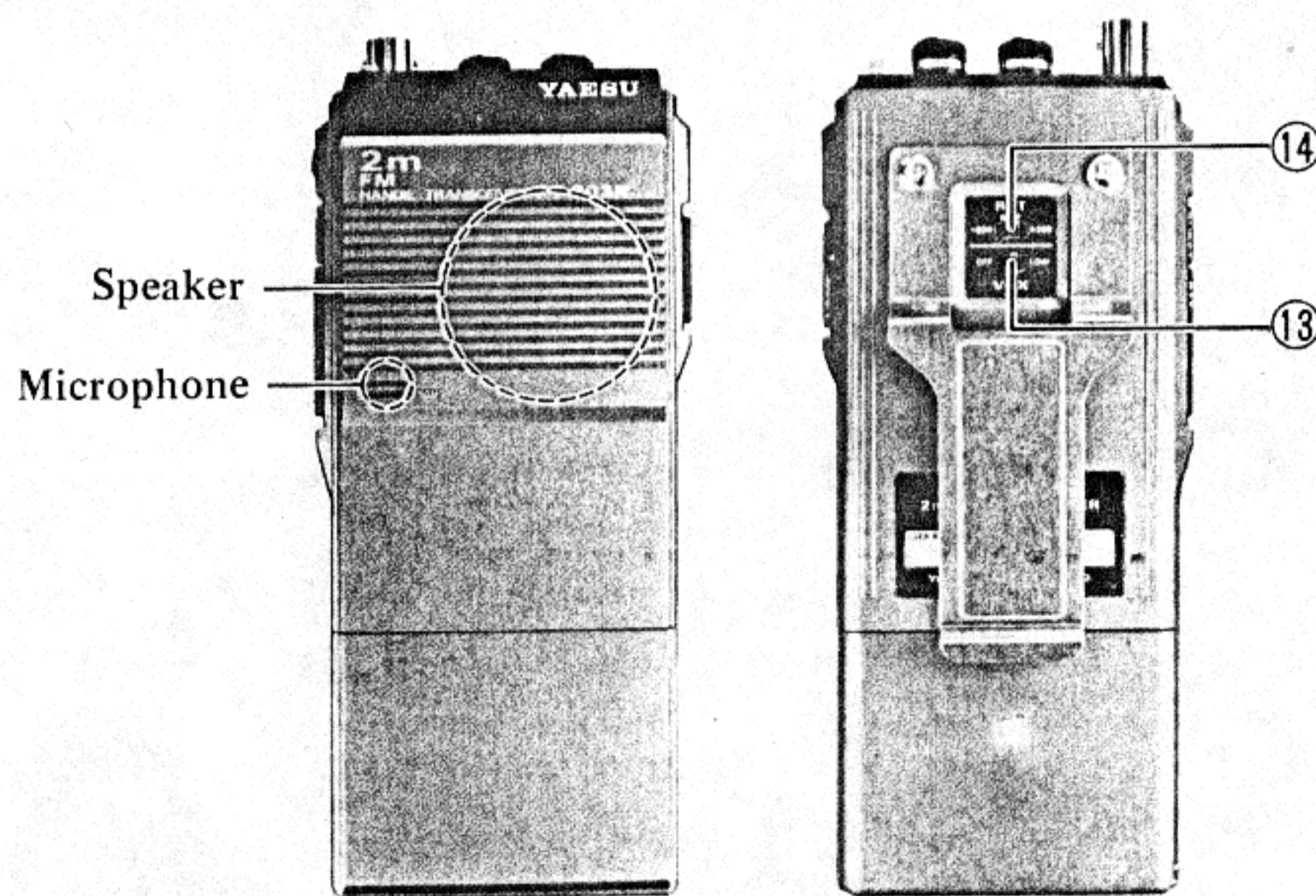
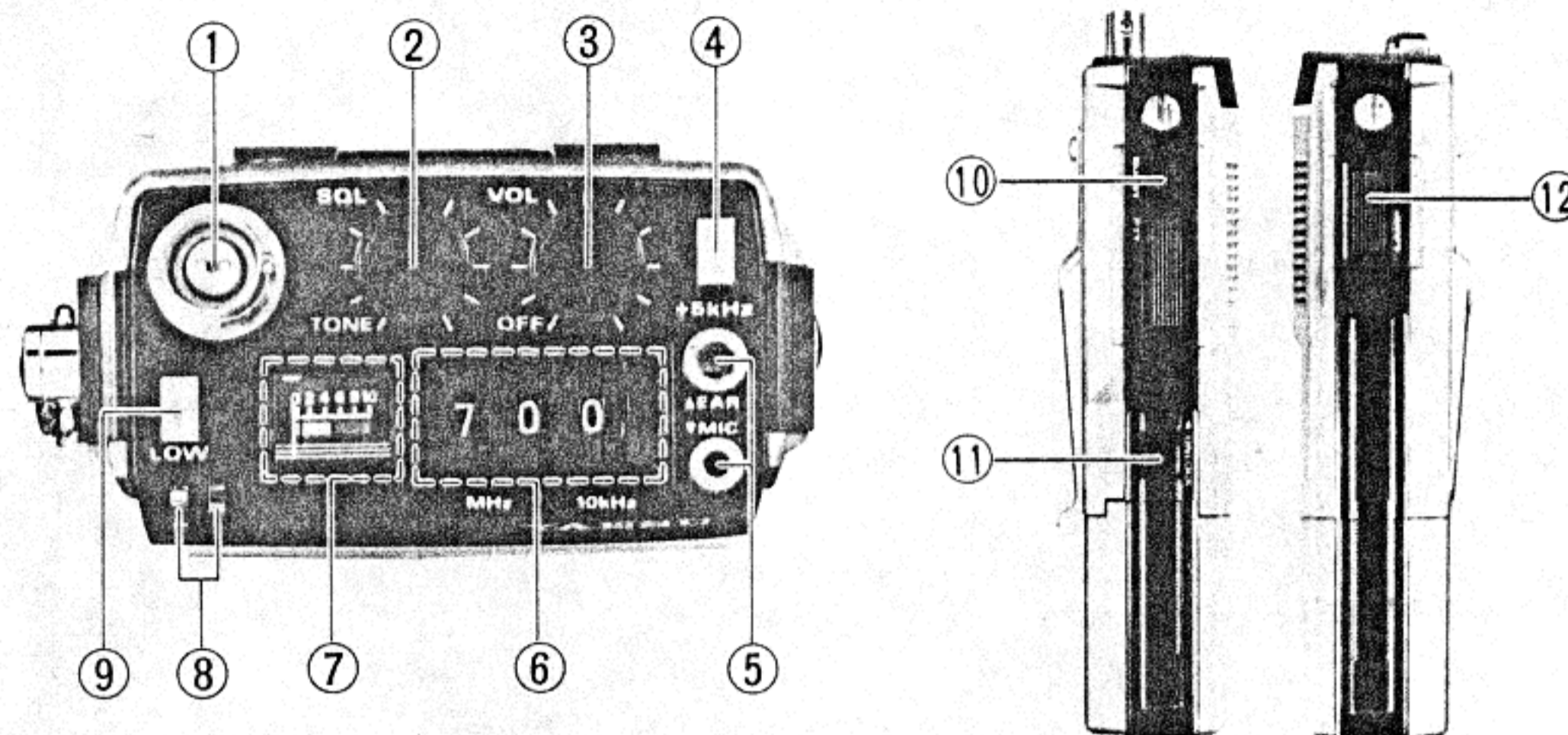

## ⑥ Thumbwheel Switches

These three rotary switches select the receiving frequency to the nearest 10 kHz (5 kHz may be added using the button with that name). The left-most thumbwheel switch, labelled MHz, selects the megahertz digit, while (unlabelled) switch in the center selects the 100-kilohertz digit. The switch labelled 10 kHz at the right selects the 10-kilohertz digit. The transmit frequency is the same as the receive frequency unless the RPT switch on the rear panel is set for a repeater split. The tens and hundreds of MHz of the frequency are not indicated.

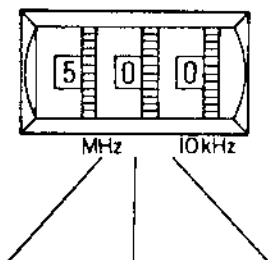

(MHz)	(100kHz)	(10kHz)
0 -	0 - 0kHz	0 - 0kHz
1 -	1 - 100kHz	1 - 10kHz
2 -	2 - 200kHz	2 - 20kHz
3 -	3 - 300kHz	3 - 30kHz
4 - 144MHz	4 - 400kHz	4 - 40kHz
5 - 145MHz	5 - 500kHz	5 - 50kHz
6 - 146MHz	6 - 600kHz	6 - 60kHz
7 - 147MHz	7 - 700kHz	7 - 70kHz
8 -	8 - 800kHz	8 - 80kHz
9 -	9 - 900kHz	9 - 90kHz

## ⑦ Meter

The meter indicates relative signal strength during reception, and relative power output during transmission. The markings on the meter scale are for relative comparisons only.

## ⑧ Indicator LEDs

The green LED indicates that the receiver squelch is open, either by noise (if the squelch threshold is set very low), or by a received signal. In normal operation, this LED is used as a "busy channel" indicator to provide a visual indication of an occupied channel. This function is important when monitoring in a noisy environment or with the volume reduced, but especially when the optional FTS-7 Tone Squelch option is installed. This LED does not function when transmitting.

The red LED indicates that the transceiver is in the transmit mode, and that RF energy is being transmitted. The receiver is disabled while the red LED is lit. If the transmitter is activated and this LED fails to light, or lights only dimly (in comparison with the green LED during reception), then a weak battery is indicated. Switch to low power and replace (or recharge) the battery as soon as possible.

The best viewing angle for the LEDs is straight down from above.

## ⑨ LOW (Power Button)

When this button is depressed, the RF output power during transmission is just a few hundred milliwatts, and power drain from the batteries is minimal, providing maximum battery (charge) life. When in the un-depressed position, RF output power during transmission is several watts, with power drain from the batteries correspondingly higher. In some cases, this (high) power selection will provide the extra punch necessary to maintain communications. However, the wise operator develops a habit of always keeping this switch in the LOW (depressed) position, except when operating the transceiver from an external power supply, or when absolutely necessary.

## ⑩ PTT Button (Left Side: and BURST on some models)

Press the PTT (Push-to-Talk) button to transmit. The BURST button is used to transmit an audible burst tone to access repeaters that require this, when using a transceiver so equipped (not generally required outside of Europe).

⑪ ◀ UNLOCK (Left Side)

To remove the battery pack, slide this spring-loaded latch upward while moving the battery pack toward this side of the transceiver.

⑫ LAMP Button (Right Side)

Press this button to illuminate the meter, when required.

⑬ VOX Slide Switch (Rear Panel)

When the optional YH-2 Headset is used with the transceiver, this switch selects VOX (voice-actuated transmit/receive) switching. The HI position is for quiet environments, providing maximum sensitivity of the VOX circuit to sound at the boom microphone on the YH-2. The LOW position desensitizes the VOX circuit to minimize triggering by extraneous sounds when operating in a noisy environment. The VOX switch is disabled when the YH-2 is not used.

⑭ RPT Slide Switch

This switch selects either simplex (SIMP) operation, or plus or minus standard transmitter frequency offsets for repeater operation.

## ANTENNA CONSIDERATIONS

While the supplied rubber flex antenna provides maximum convenience for short-range portable operation, the standard BNC-type antenna connector on the transceiver allows for the use of higher gain antennas for extended range and base station operation. However, any antenna connected to the transceiver must have an impedance close to 50 ohms in the operating frequency band. Also, if the antenna is to be connected with a feedline to the transceiver, high quality 50-ohm coaxial cable should be used.

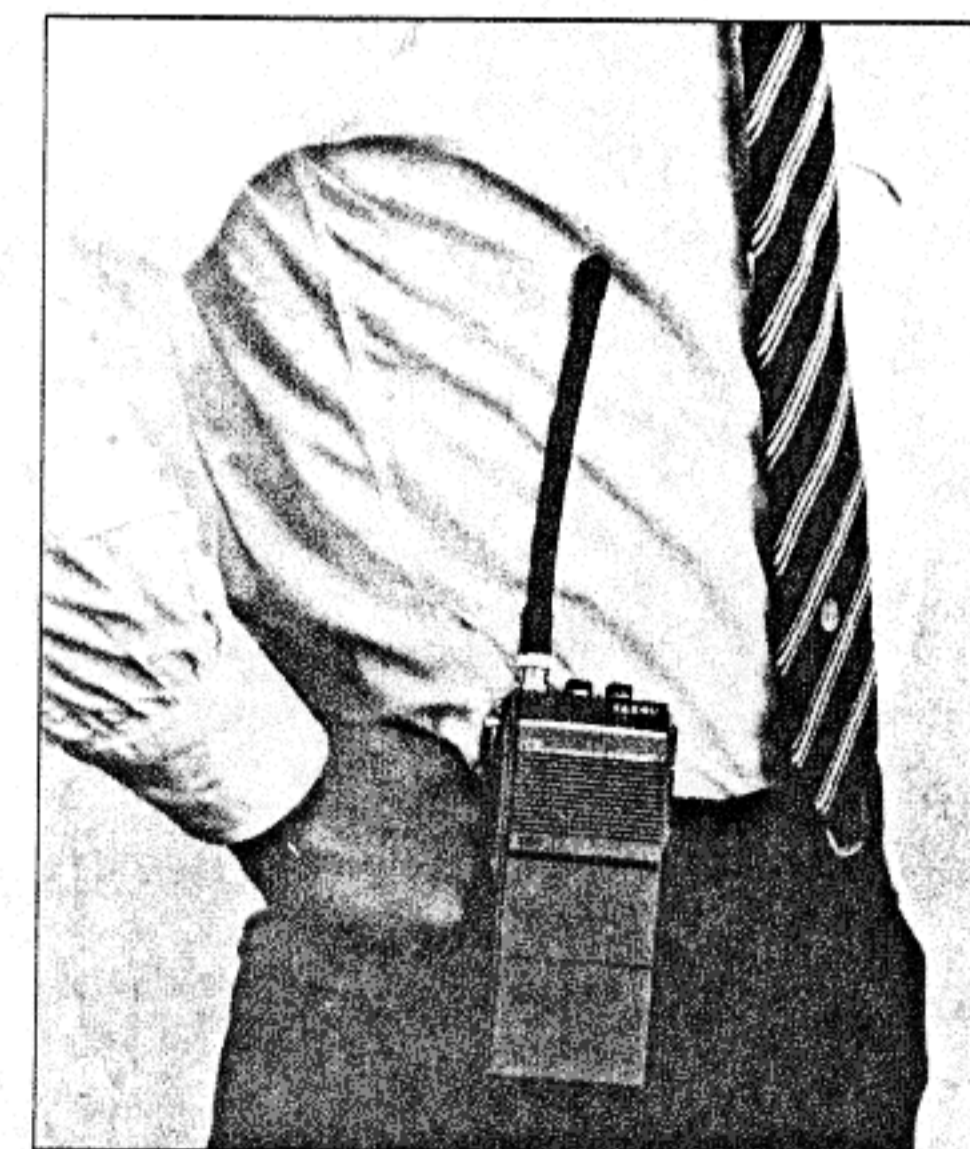
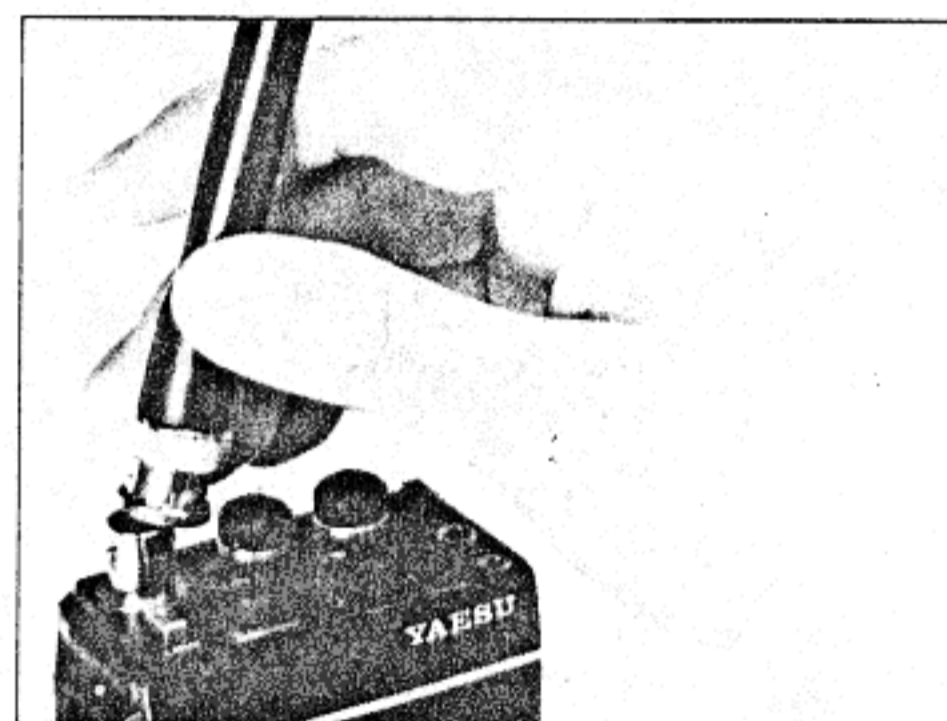

## BATTERY INFORMATION

The FNB-3 is a 10.8V, 425 mAh Ni-Cd battery pack usually supplied with this transceiver. Available as an optional accessory is the FBA-5 battery case for six AA-size dry cells (non-rechargeable, not supplied).

The FNB-3 is rechargeable, using one of the battery chargers described on pages 12 and 13. The battery pack may be charged when it is attached to the transceiver, or separately. However, we do not recommend the use of other chargers, and the warranty policy does not cover damage that may be caused by use of non-approved chargers.

RF power output from the transmitter will differ according to which type of battery is used. When fully charged, the FNB-3 will provide about 2.5 watts when transceiver is set for high power, while the FBA-5 with six fresh AA-cells will provide about 2 watts RF.



FNB-3

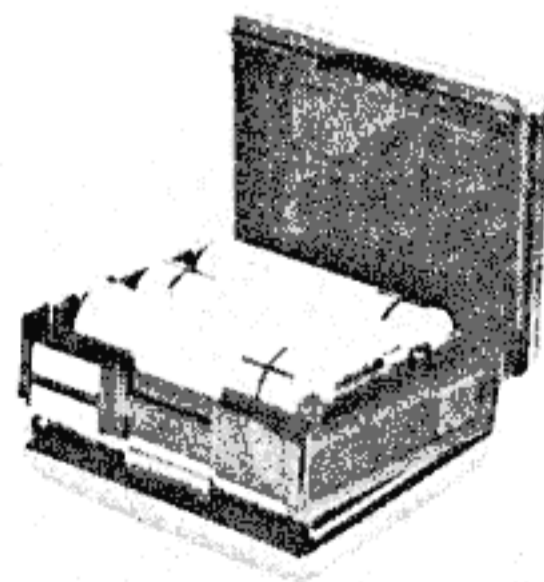

FBA-5 (option)

## Battery Replacement

1. Remove the Soft Cover from the transceiver, and make sure that the VOL control is set into the click-stop (OFF).
2. Grasp the upper portion of the transceiver with your left hand, so that your palm covers the speaker and your left thumb is on the ◀ UNLOCK button.
3. Now move the ◀ UNLOCK button in the direction indicated by the small arrowhead, while using your right hand to slide the battery case toward the side with the ◀ UNLOCK button. The battery case should slide out of its track.
4. If using the FBA-5 battery case and dry cells, they can be removed from the case by placing both of your thumbs on the mounting tracks on top of the pack and gently prying the tracks apart. Although both sides must be opened to change the cells, only one side must be opened at a time, to avoid damage to the hinges. First install or replace the three cells in one side, and then close that side, open the other side, and install or replace the other three cells. Always replace all six cells at once.
5. To replace the battery case (or Ni-Cd pack), repeat steps 2 and 3 above, simply sliding the battery case in the other direction after aligning the shorter side of the battery case with the track below the ◀ UNLOCK button.

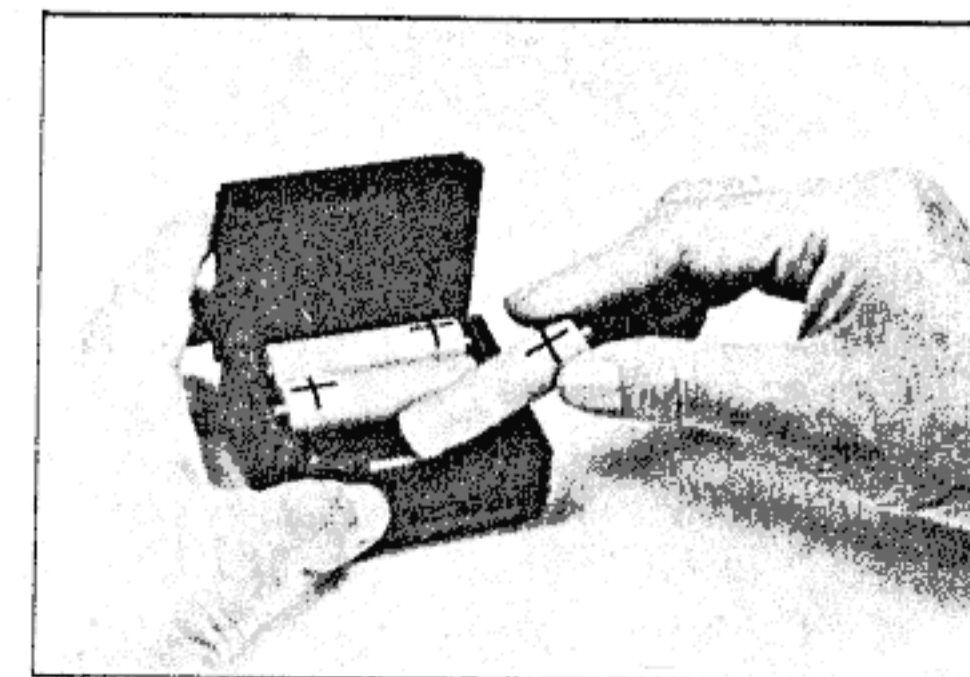
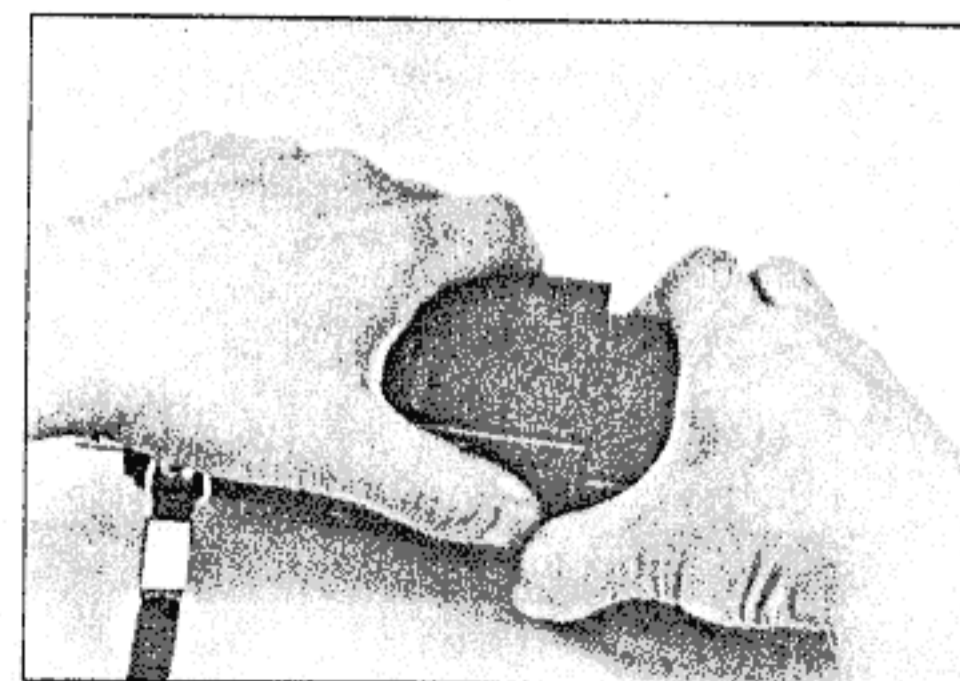

## BATTERY CHARGER INFORMATION

### NC-9B/C

The NC-9B and NC-9C are compact wall chargers for recharging the FNB-3 Ni-Cd battery pack from the AC line. The NC-9B is designed for 117 VAC, while the NC-9C is designed for 220 to 234 VAC. A completely discharged battery pack requires approximately 15 hours to recharge with the NC-9B/C.

It is not necessary to remove the battery pack from the transceiver when charging, but the transceiver can not be operated while the NC-9B/C is connected. Therefore it is advisable to have an extra battery pack on hand so that the transceiver can be operated while the spare pack is charging.

Do not attempt to recharge the dry batteries used in the FBA-5.

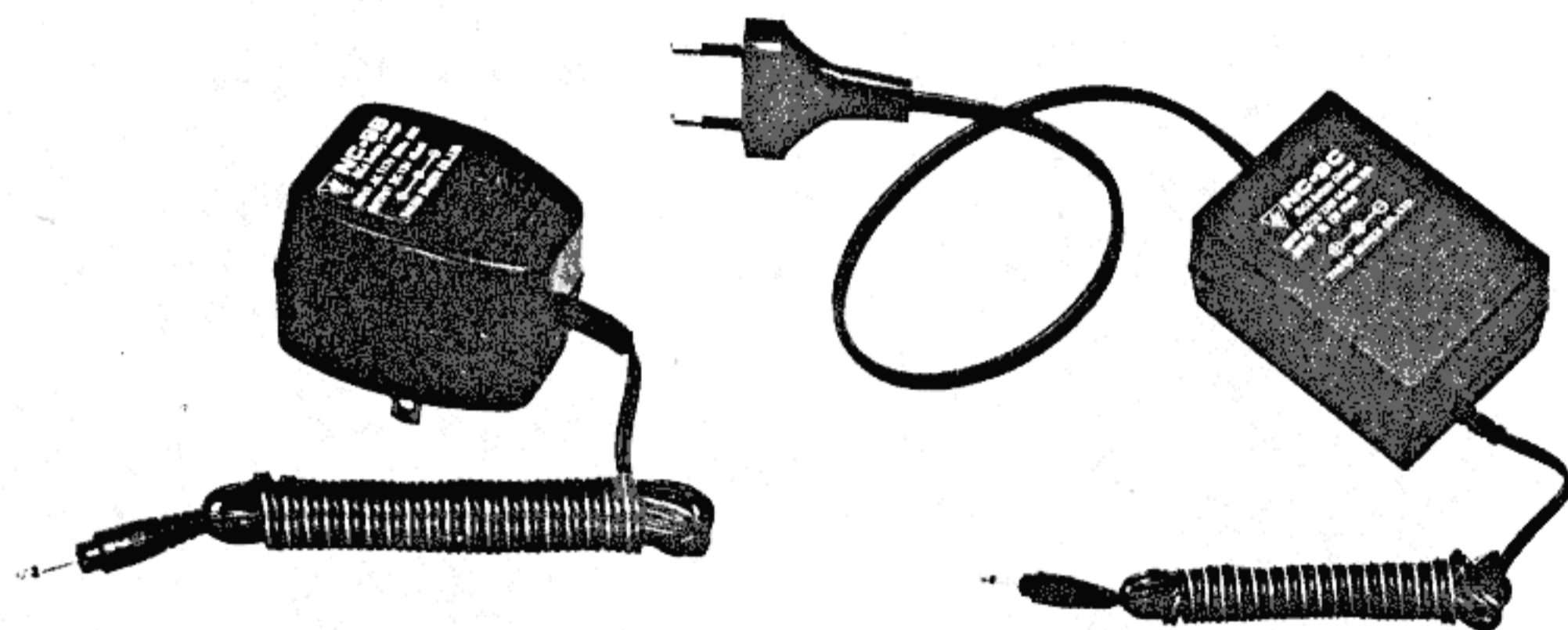

NC-9B (for 117V AC)

NC-9C (for 220-234V AC)

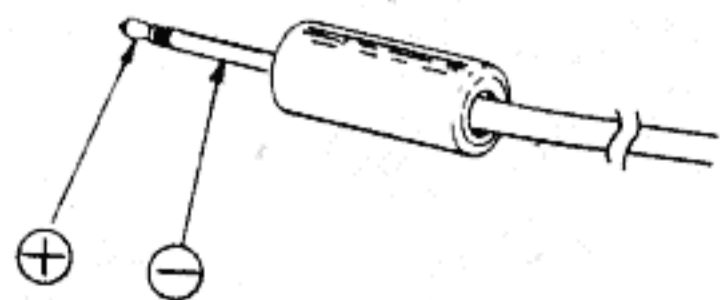

NC-9B/C CHARGE PLUG CONNECTIONS

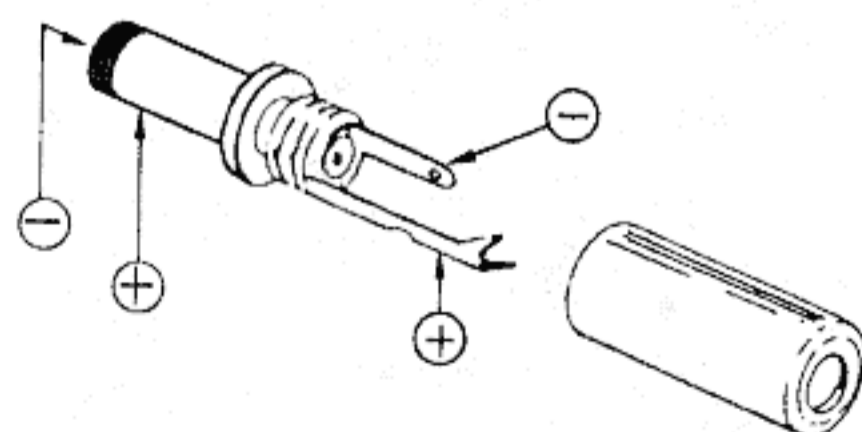

EXTERNAL DC POWER PLUG CONNECTIONS  
(Use with the FNB-3)

### NC-15

The NC-15 is a battery charger/DC adapter with two different charging modes: QUICK and TRICKLE. Either of these modes may be selected according to your battery condition. The QUICK mode charges the battery in approximately 1 hour, and the TRICKLE mode may be used to protect the battery from self-discharge when the battery is completely charged.

The DC adapter function of the NC-15 can be used to operate your transceiver, while preserving battery charge. During operation with the DC adapter, the charger function can also be activated.

### PA-3

The PA-3 is a DC-DC adapter for use when operating your transceiver from a car. The PA-3 allows you to operate while preserving battery charge, and the trickle charger function also protects the battery pack from self-discharge (FNB-3 only).

(Use only with 12-volt negative ground cars.)

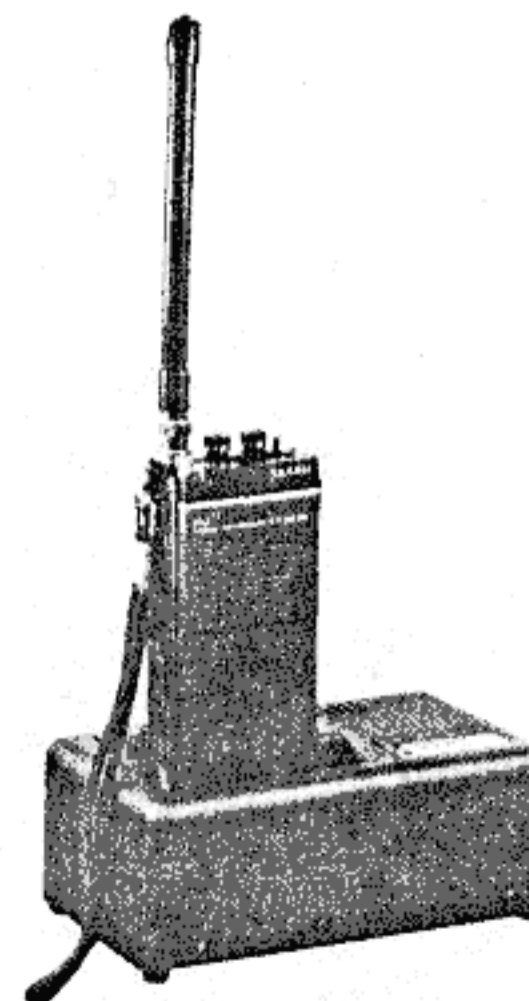

FT-203R/NC-15

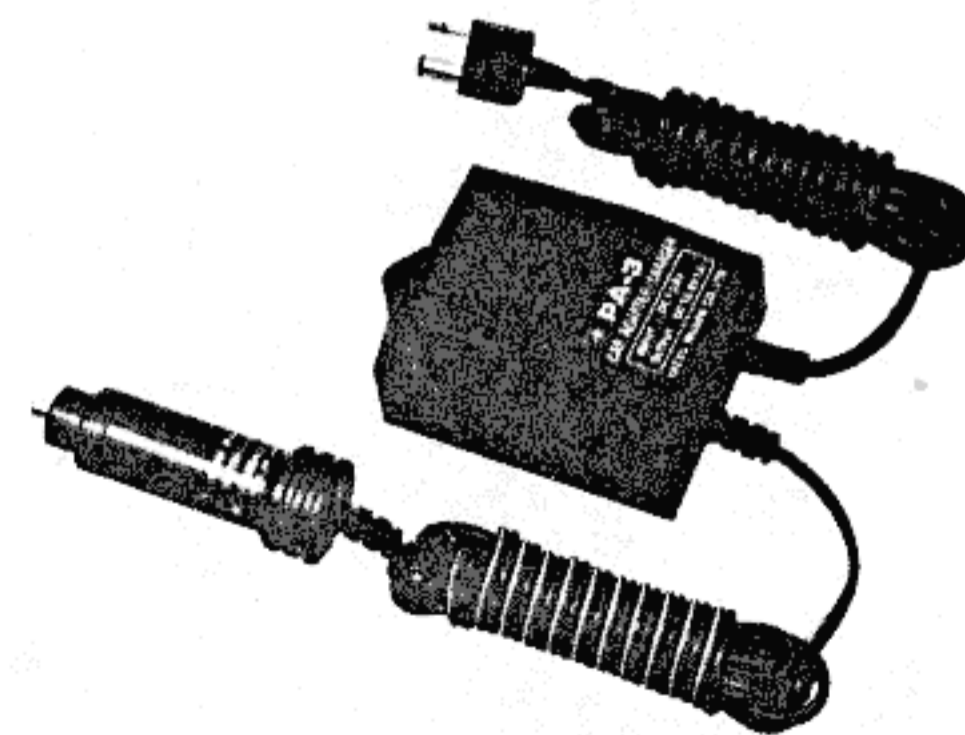

PA-3

## YH-2 HEADSET and MH-12A2B SPEAKER/MIC

Either of these two optional accessories can be used to increase operating convenience and extend operating range and signal strength. Each is equipped with a dual plug connector which mates with the EAR and MIC jacks on the top panel of the transceiver, disabling the internal speaker and microphone. The connecting cable then allows the transceiver to be left clipped to the belt during operation, or to be held above any obstructions for improved performance, if necessary. For mobile operation with the MMB-21 Mobile Hanger, the transceiver can be left in the Hanger during operation.

The MH-12A2B Speaker/Microphone can be held close to your ear during reception; or if preferred, an external earpiece can be connected to the transceiver via the speaker/mic plug, thereby attenuating the audio from the speaker in the MH-12A2B. To transmit, just hold the speaker/mic close to your mouth and close the PTT switch on the microphone.

The YH-2 Headset includes both a lightweight earphone and miniature boom microphone with a single headband, permitting totally hands-free operation of the transceiver when the VOX (voice-actuated transmit/receive switching) system in the transceiver is activated. When in a normal, quiet environment, set the VOX switch on the rear panel of the transceiver to the center (HI) position, for maximum sensitivity of the VOX circuit. If in a noisy environment where extraneous sounds might trigger the VOX inadvertently, set the VOX switch to the LOW position.

To transmit when using the YH-2, it is only necessary to speak. The boom microphone will pick up your voice, which will automatically activate the transmitter and be sent out over the air (watch what you say). To return to receive, just stop talking.

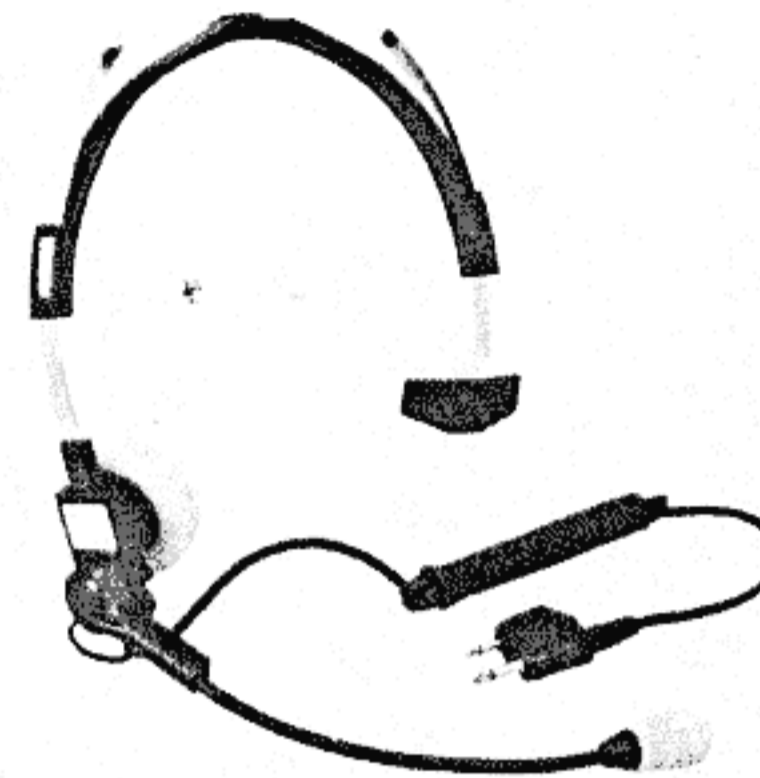

YH-2

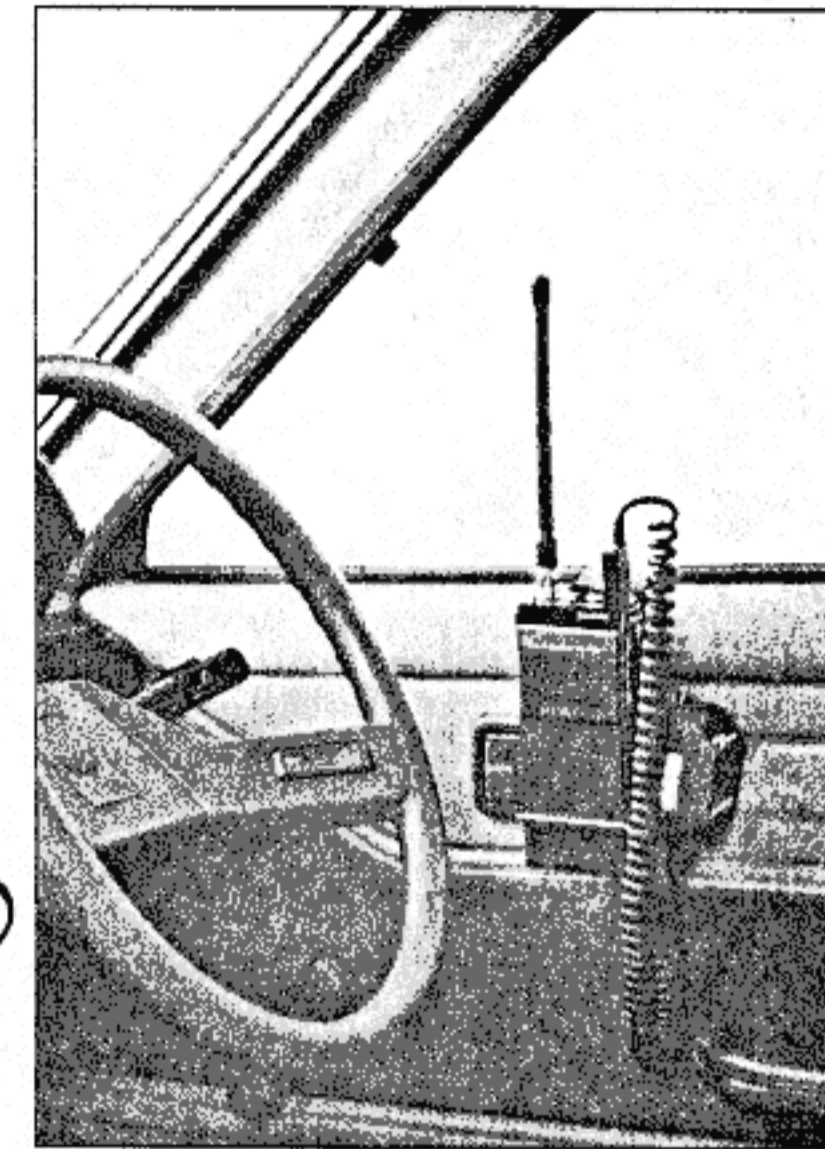

FT-203R/MH-12A2B/MMB-21



MMB-21

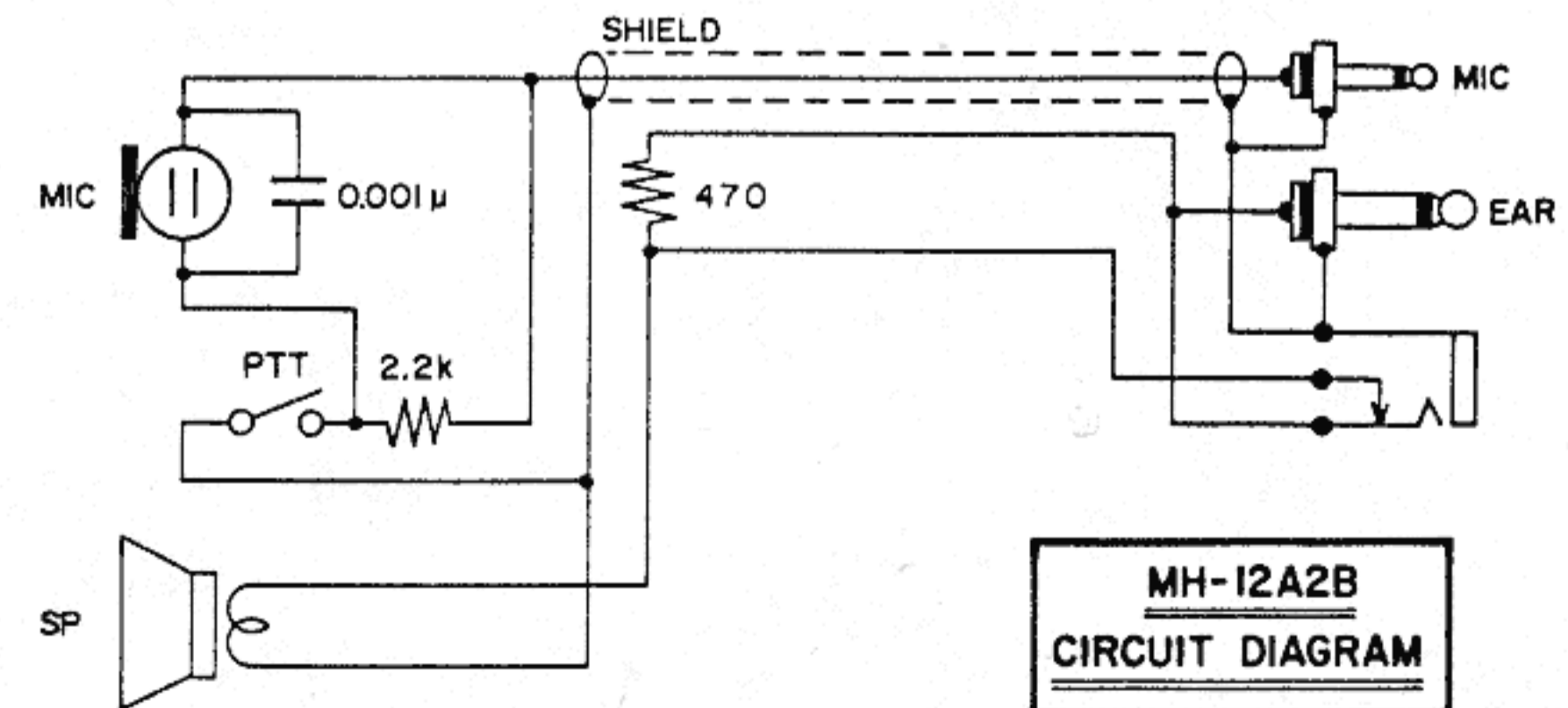
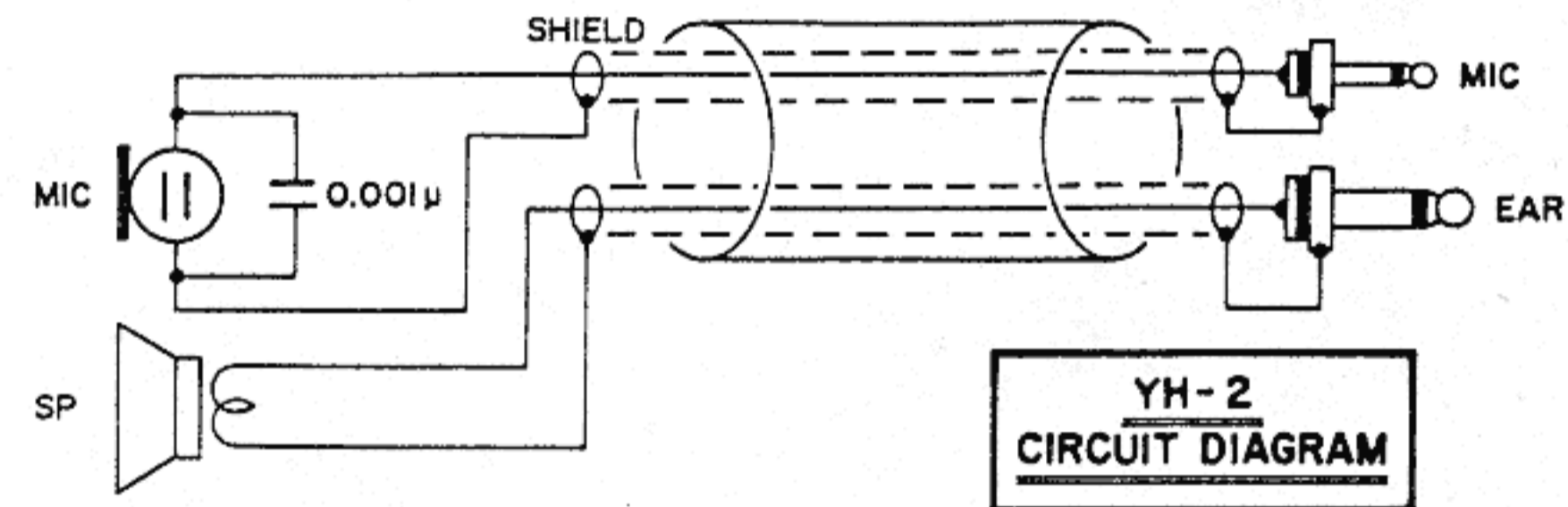



## OPERATION

Before operating the transceiver, make sure that the Ni-Cd battery pack is fully charged (if just received from the dealer, the battery pack should be charged before beginning operation). If using the FBA-5 battery case and AA-size batteries, install the batteries as described on page 11.

Connect the rubber flex antenna to the antenna jack on the top of the transceiver. Never operate the transceiver without an antenna connected.

On the top of the transceiver, set the thumbwheel switches to the desired receiving frequency, and press the +5 kHz button if necessary (for channel frequencies that are an odd multiple of 5 kHz). Press the LOW button.

On the rear of the transceiver, set the RPT switch to the - or +600 position if you are going to operate through a repeater. Otherwise, set this switch to the center (SIMP) position. Also, set the VOX switch to the OFF position.

VOX operation using the YH-2 Headset is described on page 14. For now, do not connect the YH-2 or the MH-12A2B Speaker/Mic.

With the VOL control set into the click-stop (OFF), set the SQL control fully counterclockwise but not into the click-stop. Now rotate the VOL control out of the click-stop and adjust for a comfortable volume on the noise or signal. If a signal is present, rotate one of the thumbwheel switches to a channel where only noise is heard.

Rotate the SQL control clockwise just to the point where the noise is silenced. If the SQL control is set further clockwise, sensitivity to weak signals will be reduced. If it was necessary to change channels to find a clear frequency, you can now return to the original frequency. Whenever a signal reaches the receiver that is strong enough to open the squelch, the green LED will light, indicated a busy channel.

To make a call when the channel is clear (green LED off), simply squeeze the PTT switch on the side of the transceiver, and speak into the microphone (MIC on the front panel).

During transmission, the red LED will light. If it does not, or becomes dim after several hours of operation, the battery pack should be recharged, or batteries replaced (FBA-5). If you are calling through a repeater that requires a burst tone (and using a transceiver so equipped), press the BURST button along with the PTT switch to send the tone. Release the PTT switch to receive. If more power is required, press the LOW button again so that it returns to the undepressed position. However, whenever communication is possible with low power, this button should be depressed to conserve battery life and to minimize possible interference to other stations.

In certain locations, when received signals or repeater access is weak or unstable, the signals may be improved by moving the transceiver around: in general, the higher the better. Either the YH-2 Headset or MH-12A2B Speaker/Microphone allow the transceiver to be held high overhead during operation. These accessories are described on page 14.

When operating in a dark environment, the LAMP button can be pressed to illuminate the meter.

If the FTS-7 Tone Squelch Unit is installed (model A only), rotate the SQL control into the TONE position to activate tone squelch operation. See pages 24-26 for further details of this option.

# CIRCUIT DESCRIPTION

The following information is intended to provide an understanding of the circuit design and function of the transceiver, along with the block diagram. Please refer to the schematic diagram for specific component details.

## Receiver

The VHF signal from the antenna is passed through a lowpass filter and amplified by Q<sub>1001</sub> (2SC3120) before bandpass filtering. To protect the receiver from unwanted signals that might cause cross- or intermodulation, a three-section varactor-tuned bandpass filter is used, the center frequency of which automatically tracks the receiving frequency by means of the VCV (varactor control voltage) from the PLL.

From the bandpass filter, the received signal is applied to first mixer Q<sub>1002</sub> (2SC2620B), which is also fed the first local signal. This local signal is derived from the 64 to 69 MHz 1st LO signal delivered from the PLL Unit, after doubling at Q<sub>1003</sub> (2SC2620B), buffering by Q<sub>1004</sub> (2SC2620B), and varactor-tuned bandpass filtering in a similar manner to that employed for the received signal.

The 10.695 MHz product of the first mixer is then passed through dual monolithic crystal filter pair XF<sub>1001</sub> (10L15B) before application to the second mixer section of Q<sub>1005</sub> (MC3357P). Q<sub>1005</sub> also includes limiter amplifier, discriminator, noise amplifier and squelch switching sections. The 2nd LO signal from the PLL local oscillator on the PLL Unit is also delivered to the second mixer section of Q<sub>1005</sub>, and the 455 kHz product from this section is passed from Q<sub>1005</sub> through 455 kHz ceramic filter CF<sub>1001</sub> (LF-B15) to second IF amplifier Q<sub>1006</sub> (2SC2712GR).

A portion of the 455 kHz second IF output from Q<sub>1006</sub> is further amplified by Q<sub>1007</sub> (2SC2712GR) and applied to S-meter detector D<sub>1007</sub> (1SS106) for delivery to the S-meter. The rest of the amplified second IF signal from Q<sub>1006</sub> is applied to the limiter amplifier section of Q<sub>1005</sub>, which removes any amplitude variations that may be present on the signal, before application to the discriminator section. The discriminator produces audio

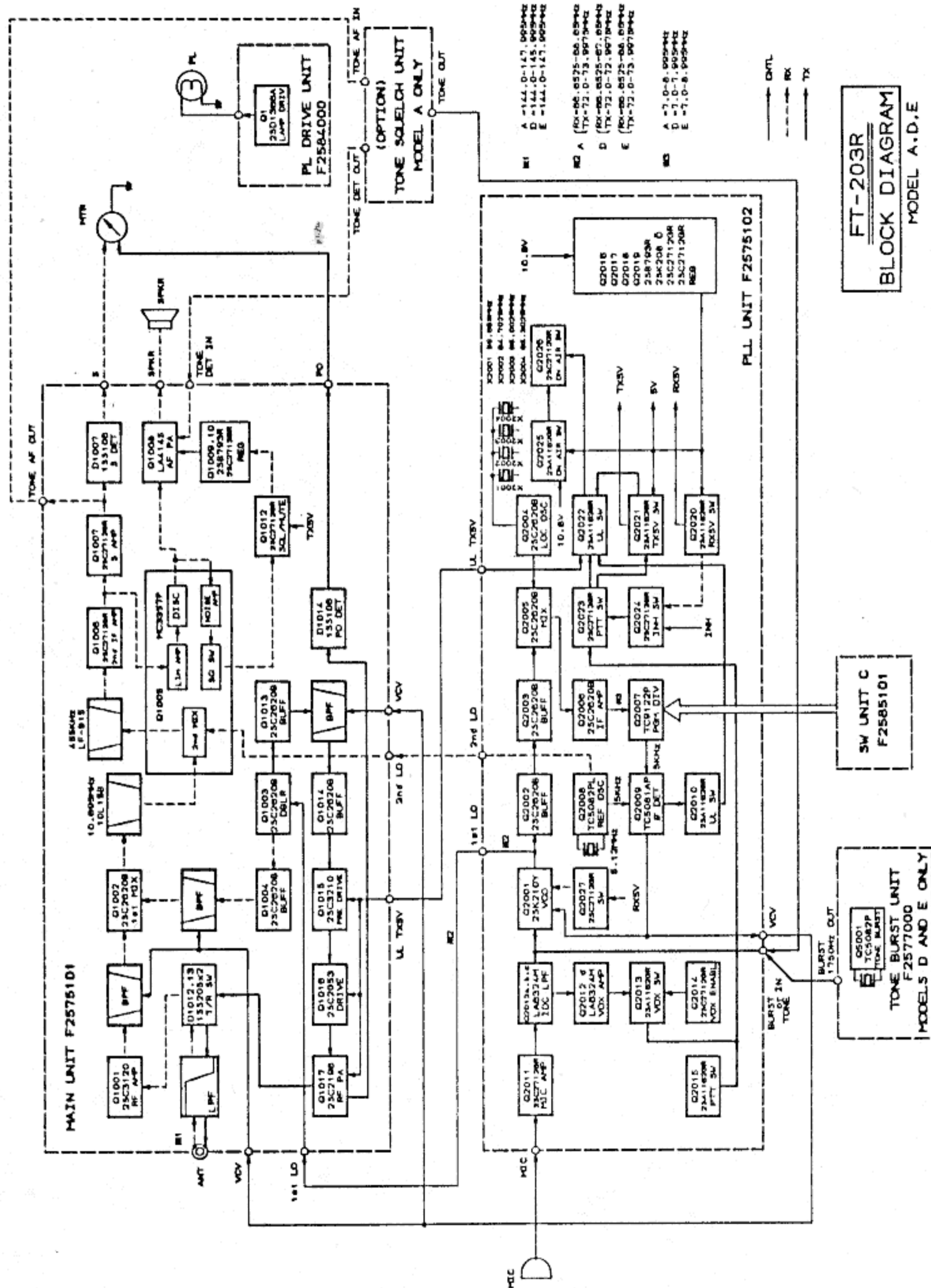

frequency output which corresponds to the frequency modulation on the input when a carrier is present, or if no carrier is present, the discriminator produces noise.

Discriminator output from  $Q_{1005}$  is applied to audio amp IC  $Q_{1008}$  (LA4145), which delivers the receiver audio to the speaker when a carrier is present in the receiver passband. When no carrier is received, the noise at the discriminator output is highpass filtered and amplified by the noise amplifier section of  $Q_{1005}$ . The noise signal is then rectified by  $D_{1006}$  (1S1555) and the resulting DC activates the squelch switch section of  $Q_{1005}$ . This switching signal then activates squelch/mute switch  $Q_{1012}$  (2SC2712GR), which disables audio amplifier  $Q_{1008}$  by biasing off regulators  $Q_{1009}$  (2SB793R) and  $Q_{1010}$  (2SC2712GR). Thus the receiver remains silent until a carrier is received.

In model A transceivers, when the FTS-7 Tone Squelch Unit is installed and activated, a sample of the discriminator output is delivered to the FTS-7. If this sample includes a subaudible tone of the same frequency as that for which the FTS-7 is programmed, audio amplifier  $Q_{1008}$  is biased on. Otherwise, the receiver remains silent.

### Transmitter

Audio from the microphone is amplified by  $Q_{2011}$  (2SC2712GR) on the PLL Unit, and fed to quad op amp  $Q_{2012}$  (LA6324M). The first three quarters of  $Q_{2012}$  serve as an IDC (instantaneous deviation control) lowpass filter, which ensures that the speech signal applied to the modulator will produce the right amount of FM deviation. The fourth quarter of  $Q_{2012}$  serves as the VOX amplifier, which activates the transmitter automatically via VOX switch  $Q_{2013}$  (2SA1162GR) when this switch is enabled by  $Q_{2014}$  (2SC2712GR). This occurs when the optional YH-2 Headset is connected to the transceiver and the operator speaks into the boom microphone while the VOX slide switch is set to the LOW or HI position. Otherwise, the operator must close the PTT switch manually to remove modulation-

inhibiting bias from VCO  $Q_{2001}$  (2SK210Y). This bias is derived from RX5V by  $Q_{2027}$  (2SC2712GR) during reception.

The filtered speech signal from  $Q_{2012}$  is applied to varactor diode  $D_{2001}$  (FC53M-3) in the VCO circuit of the PLL, which oscillates at a programmed frequency between 70 and 75 MHz. The audio thus frequency modulates the VCO, and the resulting signal is delivered to doubler  $Q_{1003}$  on the Main Unit. When the PTT line is closed, the output of  $Q_{1003}$ , which is now at the transmitting frequency, is buffered by  $Q_{1013}$  (2SC2620B) and filtered by another varactor-tuned bandpass filter to ensure clean transmitter output.

The filtered transmit signal is buffered by  $Q_{1014}$  (2SC2620B) and then amplified by  $Q_{1015}$  (2SC3120),  $Q_{1016}$  (2SC2053) and finally  $Q_{1017}$  (2SC2196) up to the final output power. A sample of the output of  $Q_{1017}$  is rectified by  $D_{2014}$  (1SS106) to provide power output indicating voltage for the meter. The transmitter output signal is then passed through T/R switching diode  $D_{2012}$  (1SS205), which is biased on by TX5V, and through a final lowpass filter to the antenna.

Closing the PTT line to transmit, either manually or via the VOX system, also causes the RF input to the receiver to be switched off through  $D_{2013}$  (1SS205), and receiver audio amplifier  $Q_{1008}$  to be disabled via squelch/mute switch  $Q_{1012}$  and regulators  $Q_{1009}$  and  $Q_{1010}$  as described previously, by applying TX5V to  $Q_{1012}$ .

When the FTS-7 Tone Squelch Unit is installed and activated (model A), or when the Tone Burst Unit is activated by the BURST button (models D and E), the respective tone is applied to modulator varactor  $D_{2001}$  in the VCO directly.

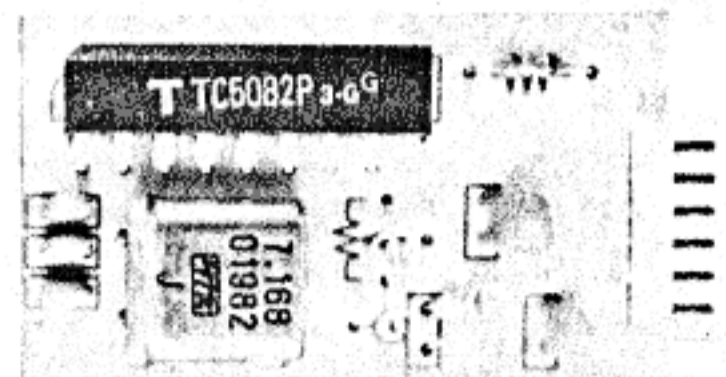

FTE-2 Tone Burst Unit

## PLL

In addition to the VCO already mentioned, the PLL circuit includes a PLL local oscillator, mixer, IF amplifier, programmable divider, reference oscillator and phase comparator. A portion of the VCO signal is buffered by Q<sub>2002</sub> and Q<sub>2003</sub> (both 2SC2620B) before being fed to PLL mixer Q<sub>2005</sub> (2SC2620B). The oscillating frequency of this VCO signal determines the operating frequency of the transceiver, and also varies for transmission and reception (even for simplex operation). Refer to the block diagram for the frequency ranges of each version.

The PLL mixer also receives a signal from PLL crystal local oscillator Q<sub>2004</sub> (2SC2620B), which oscillates at 59.655 MHz during reception; and 65.0025 MHz, or this frequency plus or minus 300 Hz during transmission (simplex, plus 600 Hz or minus 600 Hz shift, respectively). The resulting mixer product between 5 and 10 MHz is amplified by Q<sub>2006</sub> (2SC2620B) and applied to programmable divider Q<sub>2007</sub> (TC9122P), which is programmed by the thumbwheel switches to divide the PLL IF signal so that the output of Q<sub>2007</sub> is 5 kHz.

The output from the programmable divider is then applied to phase comparator Q<sub>2009</sub> (TC5081AP), which also receives a 5 kHz signal from reference oscillator/divider Q<sub>2008</sub> (TC5082PL). The result is that Q<sub>2009</sub> produces the VCV (varactor control voltage), which is a DC voltage with a level corresponding to any phase difference between the divided reference signal and the signal derived from the VCO sample. This VCV is delivered back to the varactor in the VCO, thus locking it to the reference frequency, while a portion of the VCV is also delivered to the varactor-tuned bandpass filters in the transmitter and receiver RF sections, centering each filter passband on the correct frequency for operation.

If the signals applied to the phase comparator are not locked together, Q<sub>2009</sub> activates PLL unlock switch Q<sub>2010</sub> (2SA1162GR), which in turn switches off unlock switch Q<sub>2022</sub> (2SA1162GR) to disable the ULTX5V line. This removes bias from the last three stages of the transmitter and disables the red "on air" LED via driver Q<sub>2026</sub> (2SC2712GR), which otherwise receives regulated DC from Q<sub>2025</sub> (2SA1162GR).

## PTT Switching and Voltage Regulators

Manual PTT switching is controlled by decreasing the impedance across the microphone audio line, which activates Q<sub>2015</sub> (2SA1162GR). This signal then controls Q<sub>2023</sub> (2SC2712GR), which can also be switched by VOX switch Q<sub>2013</sub> (2SA1162GR) during VOX operation, or disabled by Q<sub>2024</sub> (2SC2712GR) when the transceiver is tuned out of the amateur band. Switch Q<sub>2023</sub> controls PLL unlock switch Q<sub>2022</sub> and also TX5V switch Q<sub>2021</sub> (2SA1162GR).

Aside from the receiver audio amplifier and the final transmitter stages, the circuitry in this transceiver requires regulated 5 VDC. This is derived from the battery voltage by a four-transistor regulator composed of Q<sub>2016</sub> (2SB793R), Q<sub>2017</sub> (2SK2080) and Q<sub>2018/19</sub> (both 2SC2712GR). A portion of the resulting unswitched 5V is used to maintain oscillator operation and the VOX system, and to serve as a reference for the "on air" LED regulator, Q<sub>2025</sub>. The remaining load is switched by TX5V switch Q<sub>2021</sub> and RX5V switch Q<sub>2020</sub> (2SA1162GR) for the transmitter and receiver circuits, respectively. The TX5V switch is controlled by the T/R signal from Q<sub>2023</sub>, as described above, and the TX5V is used to control RX5V switch Q<sub>2020</sub>, so as to disable the RX5V line during transmission.

# FTS-7 PROGRAMMABLE CTCSS TONE SQUELCH ENCODER/DECODER

The FTS-7 is a DIP-switch programmable sub-audible tone generator and decoder that provides tone squelch operation using the operator's choice of 37 standard sub-audible (CTCSS) tones, for silent channel monitoring and operation through CTCSS-equipped repeaters using the Yaesu FT-203R VHF FM Hand-held transceiver (model A only).

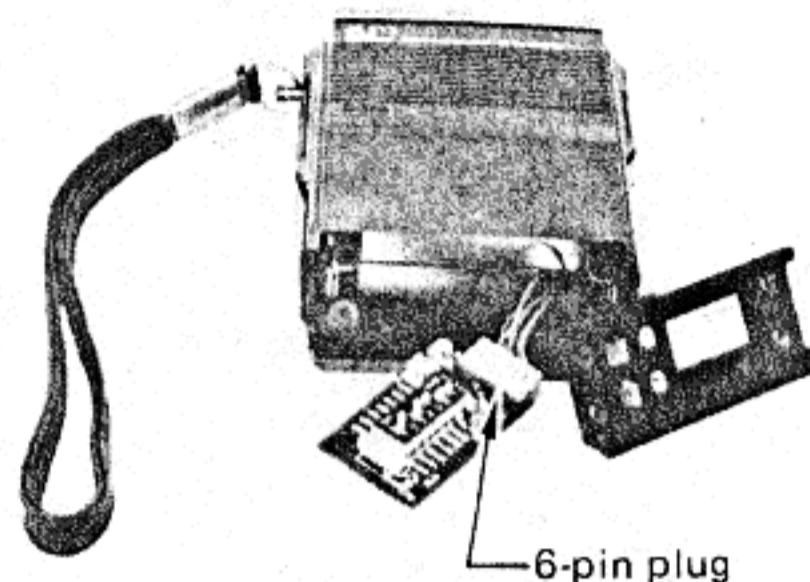

6-pin plug

## Installation

1. Set the VOL control into the click-stop (OFF), and remove the battery pack. Referring to the photo below, remove the four screws affixing the battery mounting track, and remove the track.
2. Locate the 6-pin plug inside the bottom of the transceiver, and connect this plug to J<sub>01</sub> on the edge of the FTS-7 (See diagrams at right).
3. Apply the double-sided adhesive pad (supplied with the Kit) to the IC side of the FTS-7, and mount the FTS-7 inside the bottom of the transceiver as shown below. Now replace the battery mounting track and its four screws.

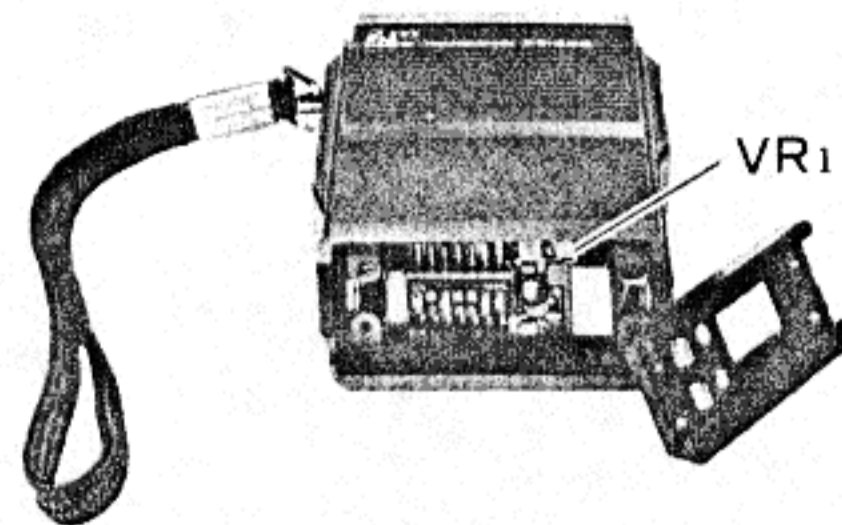
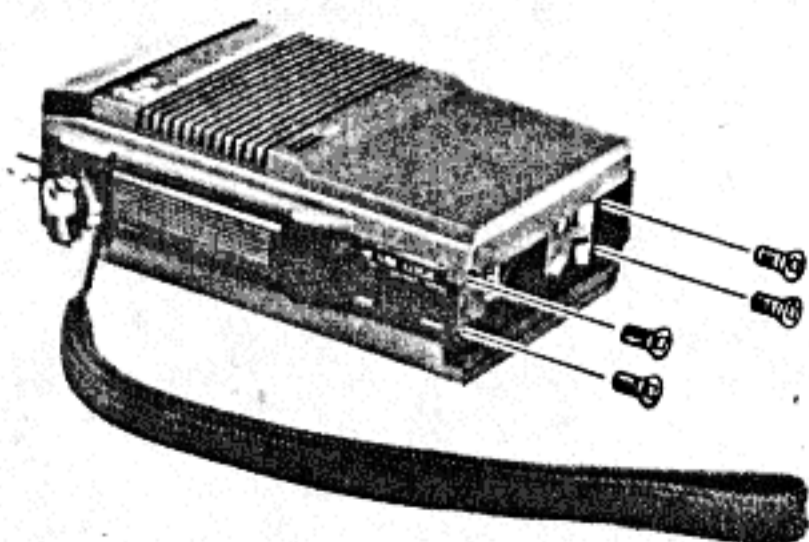
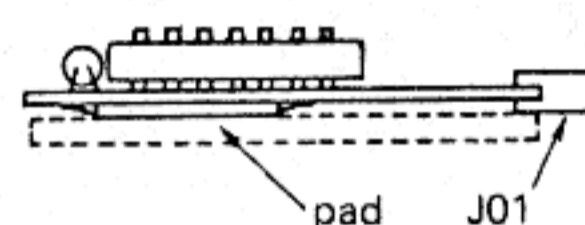
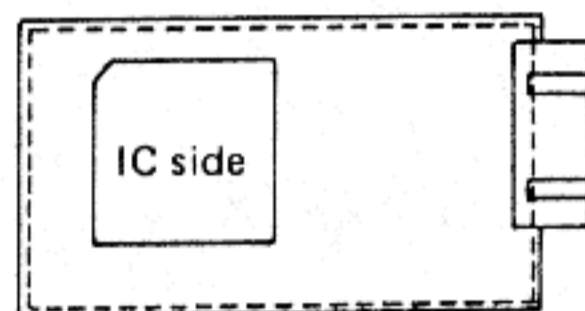

## Programming

With the battery pack removed, refer to the DIP Switch Programming Chart below, and set the six switches on the FTS-7 for the desired tone (the switches should be accessible through the hole in the bottom of the transceiver). Note that "o" in the Chart indicates that the switch should be set to the "ON" position. Switch number 7 should only be set to the "OFF" position if tone squelched reception is not to be used while CTCSS transmission is required.

### EXAMPLES

FREQ	SWITCH NUMBER *					
	1	2	3	4	5	6
67.0Hz	o	-	-	-	-	-

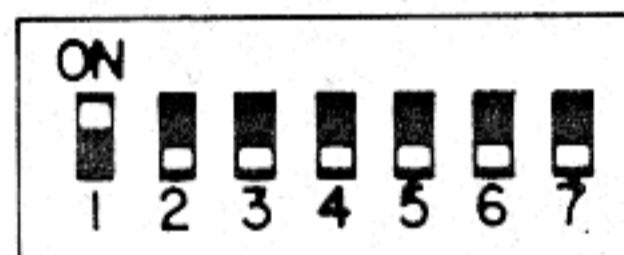

67.0Hz

ON = Enc/Dec  
OFF = Encoder only

FREQ	SWITCH NUMBER *					
	1	2	3	4	5	6
77.0Hz	o	o	-	-	-	-

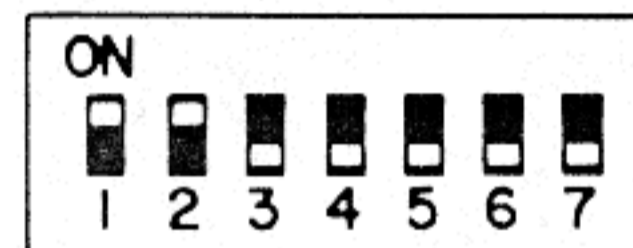

77.0Hz

FREQ	SWITCH NUMBER *					
	1	2	3	4	5	6
88.5Hz	o	-	o	-	-	-

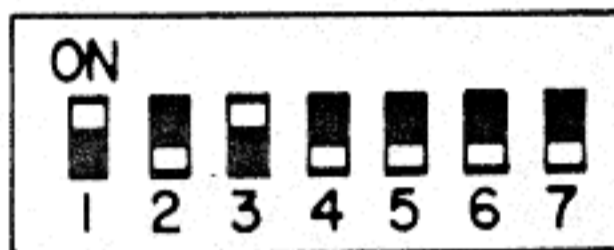

88.5Hz

### FTS-7 DIP SWITCH PROGRAMMING

FREQ	SWITCH NUMBER *						FREQ	SWITCH NUMBER *					
	1	2	3	4	5	6		1	2	3	4	5	6
67.0Hz	o	-	-	-	-	-	136.5Hz	-	-	-	-	o	-
71.9	-	o	-	-	-	-	141.3	o	-	-	-	o	-
74.4	-	-	o	-	-	-	146.2	-	o	-	-	o	-
77.0	o	o	-	-	-	-	151.4	o	o	-	-	o	-
79.7	-	o	o	-	-	o	156.7	-	-	o	-	o	-
82.5	-	-	o	-	-	-	162.2	o	-	o	-	o	-
85.4	-	-	-	o	-	o	167.9	-	o	o	-	o	-
88.5	o	-	o	-	-	-	173.8	o	o	o	-	o	-
91.5	-	o	-	o	-	o	179.9	-	-	-	o	o	-
94.8	-	o	o	-	-	-	186.2	o	-	-	o	o	-
100.0	o	o	o	-	-	-	192.8	-	o	-	o	o	-
103.5	-	-	-	o	-	-	203.5	o	o	-	o	o	-
107.2	o	-	-	o	-	-	210	-	-	o	o	o	-
110.9	-	o	-	o	-	-	218.1	o	-	o	o	o	-
114.8	o	o	-	o	-	-	225.7	-	o	o	o	o	-
118.8	-	-	o	o	-	-	233.6	o	o	o	o	o	-
123.0	o	-	o	o	-	-	241.8	-	-	-	-	o	-
127.3	-	o	o	o	-	-	250.3	o	-	-	-	-	o
131.8	o	o	o	o	-	-							

\* DIP SW o = ON

DIP SW NO ⑦ ON = TONE SQUELCH  
OFF = ENCODER ONLY

## Tone Level Adjustment

The tone output level of the FTS-7 is preset at the factory for the standard level, and normally requires no readjustment. However, if a particular situation requires a different tone level, this may be adjusted by trimmer potentiometer VR<sub>01</sub>, shown in the right-hand photo at the bottom of page 24.

## Operation

To activate the FTS-7, simply set the SQL control fully counterclockwise into the click-stop (TONE). During reception, the transceiver will remain silent until a signal is received that includes the programmed subaudible tone, at which time the squelch will open and the station will be heard as usual. When the transmitter is activated, a subaudible tone will be superimposed upon your voice signal, so that those stations equipped with a CTCSS decoder set to the same tone frequency will hear your call. Stations not equipped with tone squelch units will also be able to hear your transmissions, but you will not hear them when they transmit. Normal operation remains the same when the SQL control is rotated out of the TONE position.

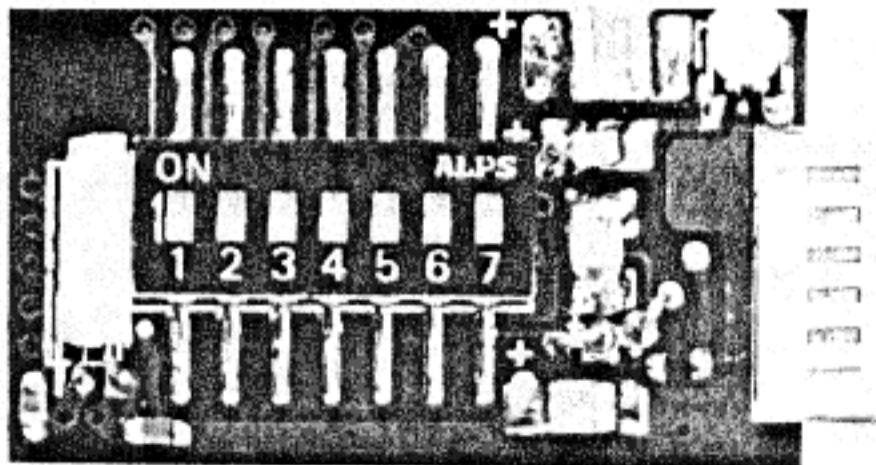

FTS-7

## MAINTENANCE AND ALIGNMENT

This transceiver has been carefully aligned and tested at the factory prior to shipment. If not abused, it should not require other than the usual attention given to electronic equipment: do not store for long periods of time with the battery installed, protect from high temperature and humidity, avoid dusty or sandy environments, and do not drop the transceiver on a hard surface.

Should service be required, we recommend that the transceiver be returned to the dealer from whom it was purchased. This is necessary to make use of the warranty policy, and also to ensure that a properly qualified technician performs the service.

Replacement of a major component may require considerable realignment. Under no circumstances, though, should realignment be attempted unless the operation of the transceiver circuitry is completely understood. The malfunction should first be carefully analyzed, and any faulty parts replaced before alignment. Service must only be performed by experienced personnel using the proper test equipment.

A 50-ohm dummy load must be connected to this transceiver at all times when the transmitter is activated during alignment. Troubleshooting or alignment using an antenna can result in misleading indications on the test equipment. Also, while this transceiver can operate from a wide range of DC supply voltages, all alignment steps require 10.8 VDC only. Do not use any other voltage for alignment.

### Test equipment required:

- DC Voltmeter with 10-megohm impedance
- DC Milliammeter
- RF Voltmeter accurate to 170 MHz
- AF Millivoltmeter
- RF Signal Generator with calibrated output to 170 MHz
- Audio Signal Generator
- SINAD Meter
- FM Linear Detector (Deviation Meter)
- Directional (CM) Sampling Coupler
- 50-ohm Terminated Wattmeter
- Frequency Counter accurate to 170 MHz

### Case Removal

1. Referring to the exploded view, remove the battery case or pack, and then remove the four screws affixing the battery mounting track.
2. Remove the two screws affixing the belt clip, and finally the strap mounting screw and the strap mounting dummy screw.
3. Separate the front and rear panels carefully from the chassis, so as not to damage the wiring to the speaker and microphone on the front panel. Note carefully the way in which the PTT and LAMP buttons are hinged.

### OVERALL EXPLODED VIEW

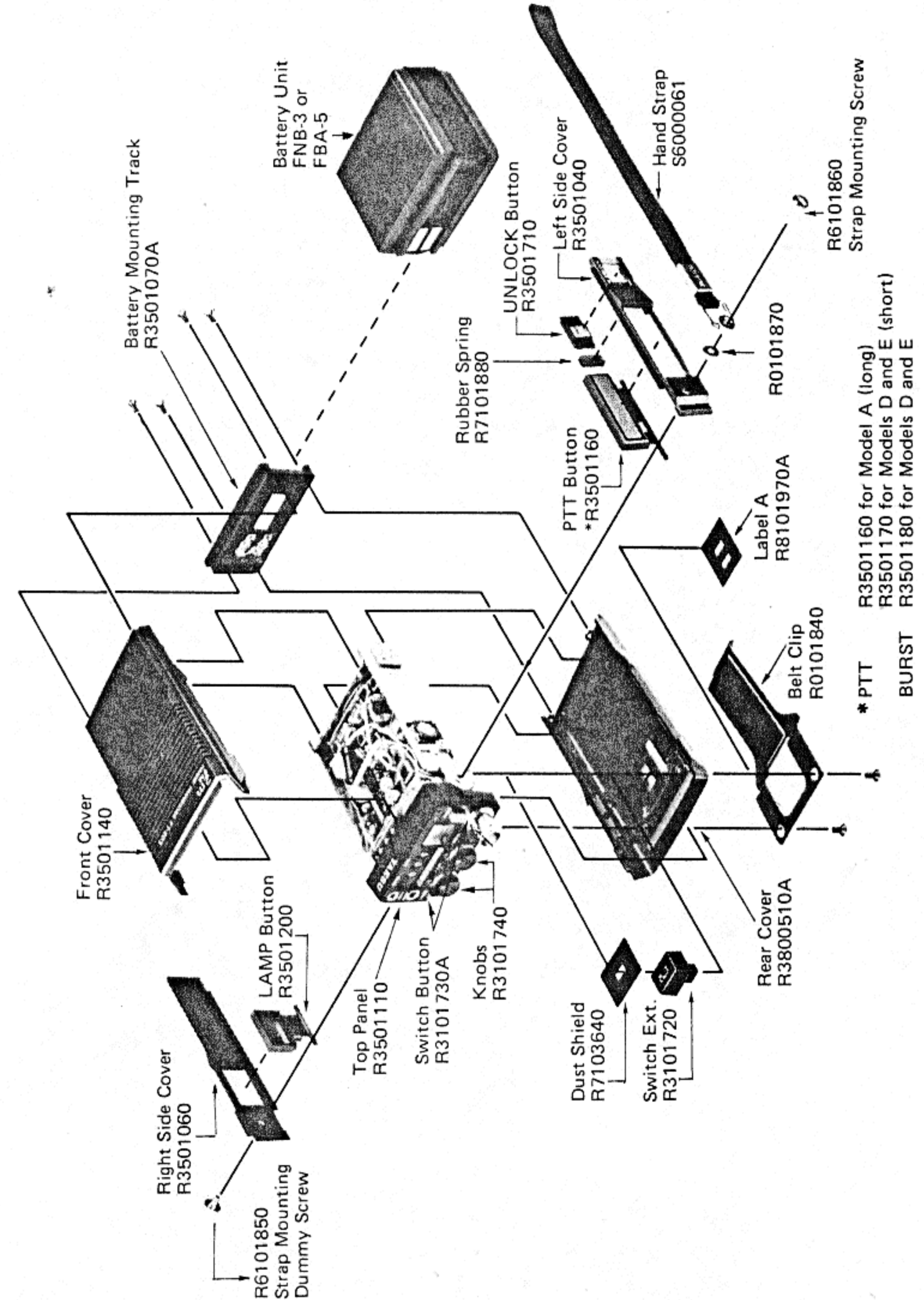

## PLL Circuit

Because of certain thermally sensitive, interacting components in the PLL circuitry, particular attention must be paid to assure a constant ambient temperature at the circuit during alignment. If the transceiver temperature is different than that of the alignment environment, allow sufficient time for thermal equalization before proceeding. Alignment temperature must remain constant and be within the range of 20 to 30°C (68 to 86°F).

Furthermore, proper alignment requires that the shield cover be in place over the VCO, and that the circuit board be mounted in place on the chassis.

### A. PLL Local Output Transformer

With the transceiver set to the center of the operating band (145.0 or 146.0 MHz), connect the RF voltmeter to the collector of Q<sub>2006</sub> and adjust T<sub>2001</sub> for maximum deflection on the voltmeter (at least 750 mVrms).

### B. VCV

With the transceiver set to the low edge of the operating band, connect the high impedance DC voltmeter between pin 3 of JP<sub>2001</sub> and chassis ground, and adjust L<sub>2003</sub> for 1.0V on the meter.

### C. PLL Local Frequency

1. Set the transceiver to the center of the operating band (145.0 or 146.0 MHz) and connect the frequency counter to the collector of Q<sub>2003</sub>.
2. With the +5 kHz button in the undepressed position, refer to Table I and adjust L<sub>2008</sub>, L<sub>2012</sub>, L<sub>2014</sub> and L<sub>2010</sub> for the frequencies indicated for the model type being aligned. Set the RPT switch to the appropriate position for each transmit adjustment.
3. Now press the +5 kHz button and referring to Table II, adjust L<sub>2007</sub>, L<sub>2011</sub>, L<sub>2013</sub> and L<sub>2009</sub> for the frequencies indicated for the model type being aligned, as in the previous step.

PLL UNIT Adjustment Points  
(viewed from rear)

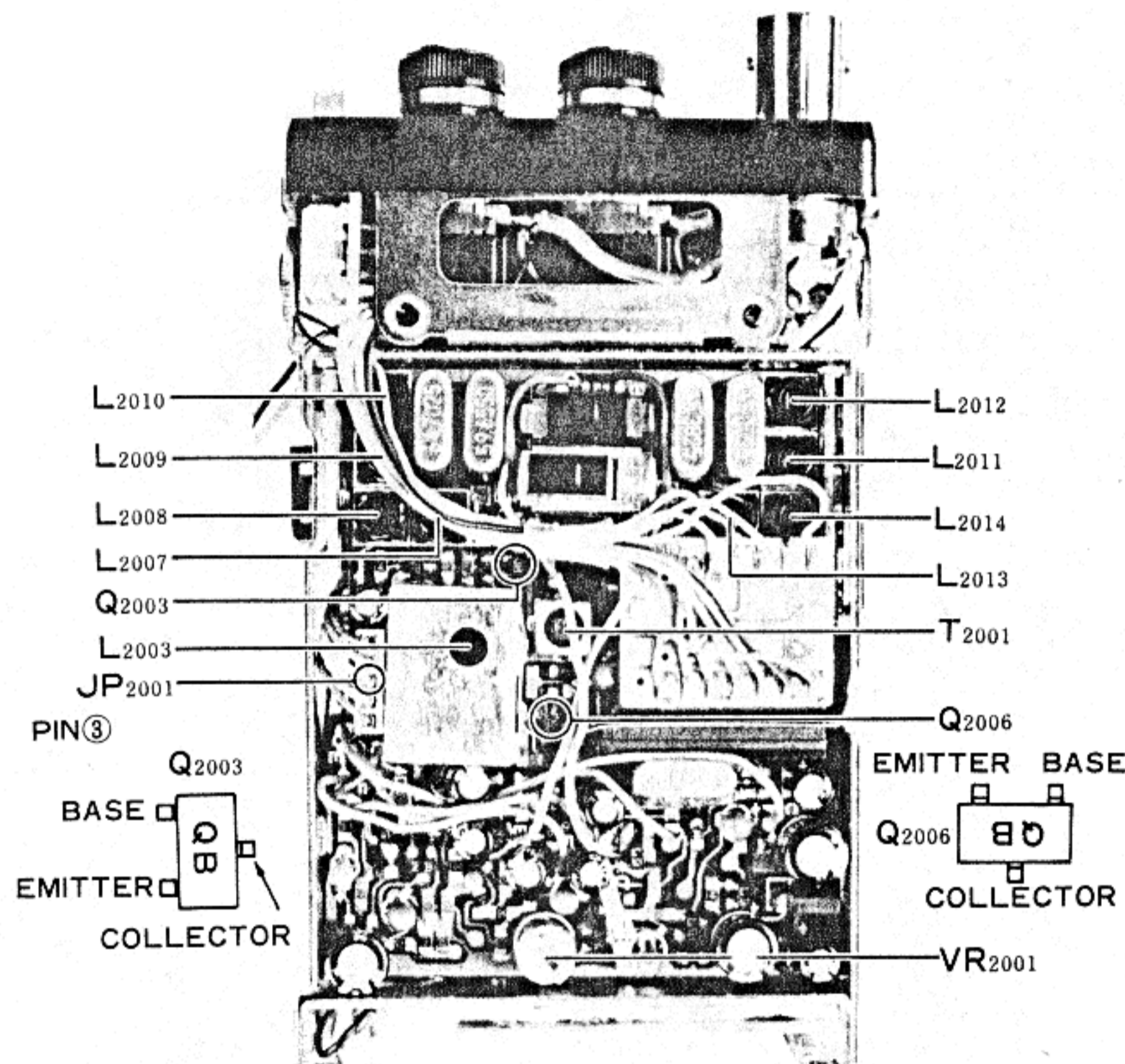

Table I PLL Local Frequency Adjustment  
(+5 kHz button not depressed)

MODEL	RECEIVE (L <sub>2008</sub> )	TRANSMIT		
		SIMPLEX (L <sub>2012</sub> )	RPT+600 (L <sub>2014</sub> )	RPT-600 (L <sub>2010</sub> )
A and E	67.6525	73.0000	73.3000	72.7000
D	67.1525	72.5000	72.8000	72.2000

Table II PLL Local Frequency Adjustment  
(+5 kHz button depressed)

MODEL	RECEIVE (L <sub>2007</sub> )	TRANSMIT		
		SIMPLEX (L <sub>2011</sub> )	RPT+600 (L <sub>2013</sub> )	RPT-600 (L <sub>2009</sub> )
A and E	67.6550	73.0025	73.3025	72.7025
D	67.1550	72.5025	72.8025	72.2025



## Receiver

### A. Signal Path

1. Connect the test equipment as shown in the following diagram, and tune the transceiver and generator to 145.00 MHz. Modulate the signal generator with 1 kHz of audio with  $\pm 3.5$  kHz FM deviation, and set the generator output level to  $0.25 \mu\text{V}$  ( $-6 \text{ dB}\mu$ ).
2. Adjust T<sub>1001</sub> through T<sub>1009</sub> to obtain optimum SINAD, which should be 12 dB or better.

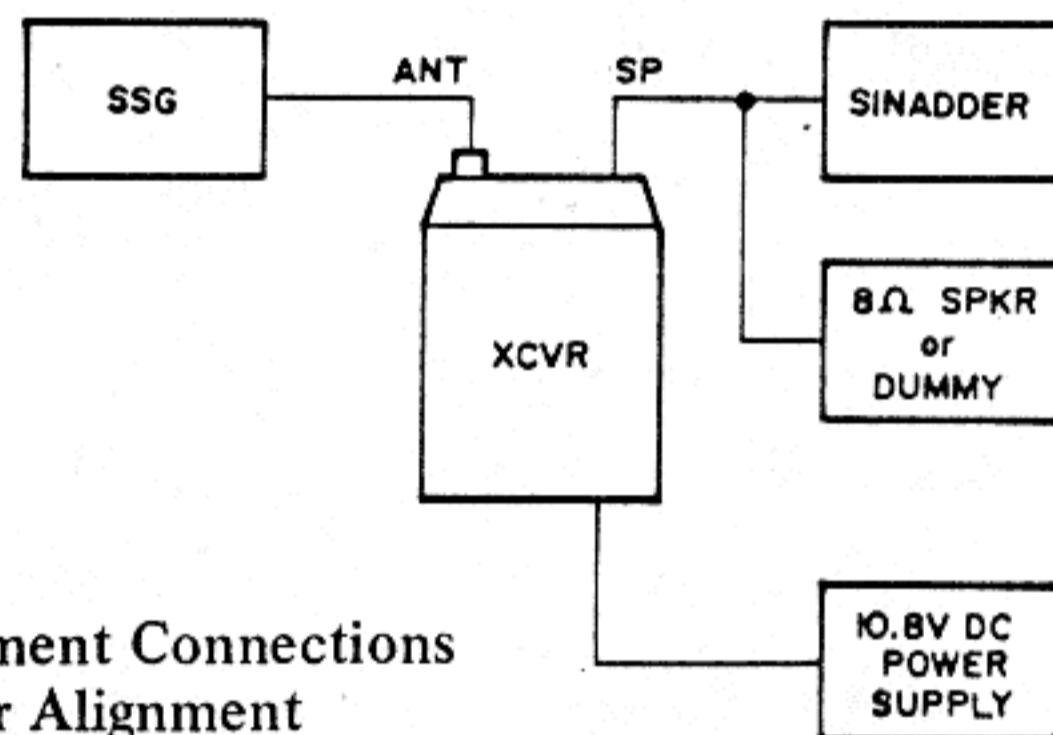

Test Equipment Connections  
for Receiver Alignment

### B. Squelch Circuit

1. With the transceiver tuned to 145.00 MHz, replace the signal generator with the dummy load at the antenna jack. Set the SQL control to midrange, and adjust VR<sub>1001</sub> to the point where receiver noise is just squelched off.
2. Reconnect the signal generator to the antenna jack, and set the SQL control fully counterclockwise into the click-stop (TONE) position. With the same signal generator modulation as in step 1 of the previous procedure, set the generator output level to  $8 \text{ dB}\mu$  and adjust VR<sub>1003</sub> to the squelch threshold point.

## MAIN UNIT Adjustment Points (viewed from front)

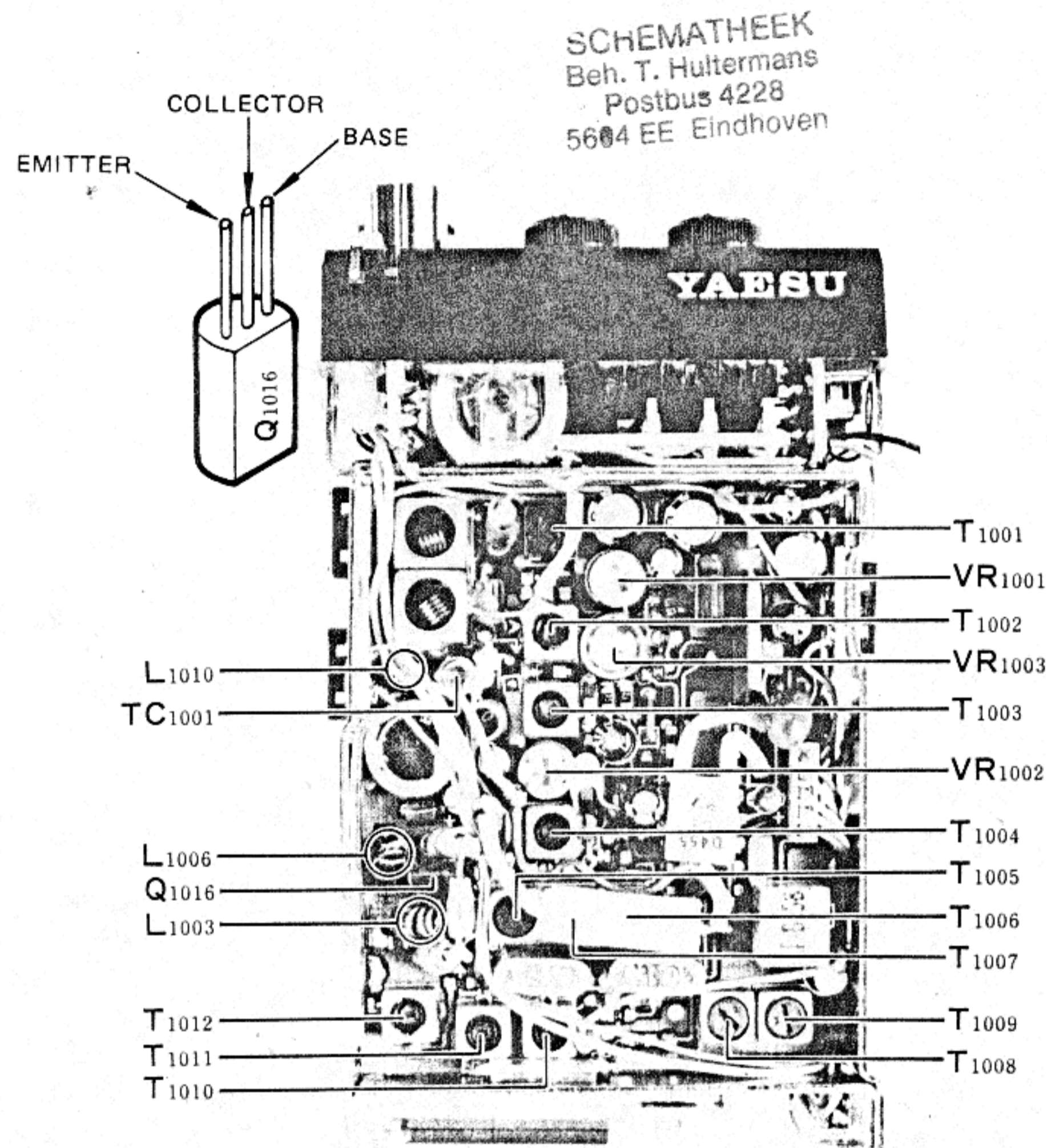

## Transmitter

Do not transmit without a 50-ohm dummy load connected to the antenna terminal.

### A. Signal Path

1. With the terminated wattmeter connected to the antenna jack and the transceiver set to 145.00 MHz, connect the DC voltmeter to the emitter of  $Q_{1016}$  and adjust  $T_{1010}$  through  $T_{1012}$  for maximum DC voltage during transmission (at least 700 mV). If necessary, also adjust the pitch of coil  $L_{1003}$  for maximum voltage.
2. With the LOW switch in the out (high power) position, adjust the pitch of  $L_{1006}$  and  $L_{1010}$ , and also the setting of  $TC_{1001}$  for maximum RF output power during transmission (3W nominal @ 10.8 VDC supply).
3. Connect the milliammeter in series with the power supply and adjust  $TC_{1001}$  so that transmitter power output is limited to 2.7W. Supply consumption should be 800 mA or less.

### B. PO Meter Setting

With the LOW switch in the out (high power) position, adjust  $VR_{1002}$  so that the meter on the transceiver deflects to "8" on the numbered scale.

## C. Modulator

1. Connect the test equipment as shown below, and set the audio generator for 25 mV output at 1 kHz. Adjust  $VR_{2001}$  for  $\pm 4.5$  kHz deviation on the deviation meter while transmitting.
2. Reduce the output level of the audio generator while observing the deviation meter, to obtain  $\pm 3.5$  kHz deviation. The audio generator output level should now be between 1 and 3 mV.

Test Equipment Connections for Modulator Alignment

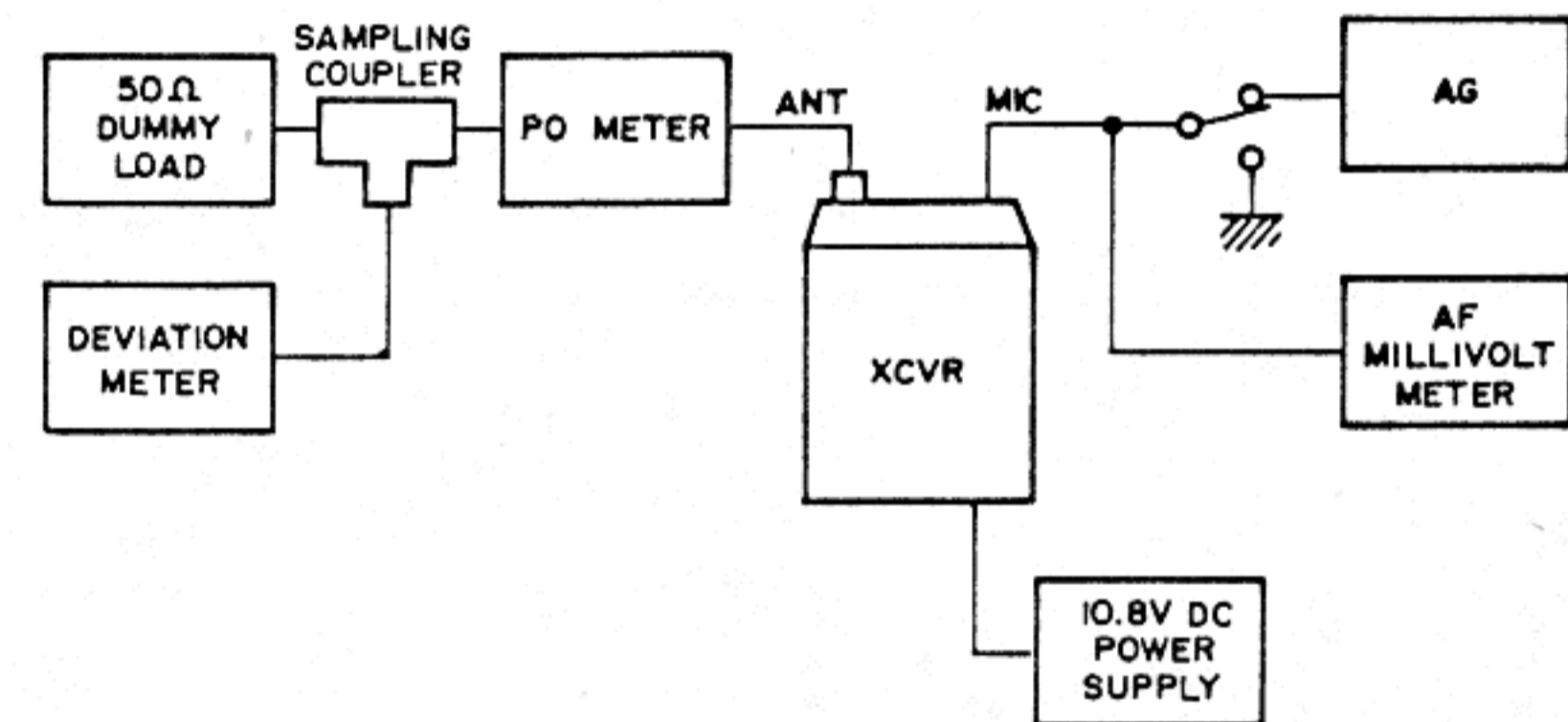

POWER SUPPLY (BATTERY CASE or PACK) CONNECTIONS

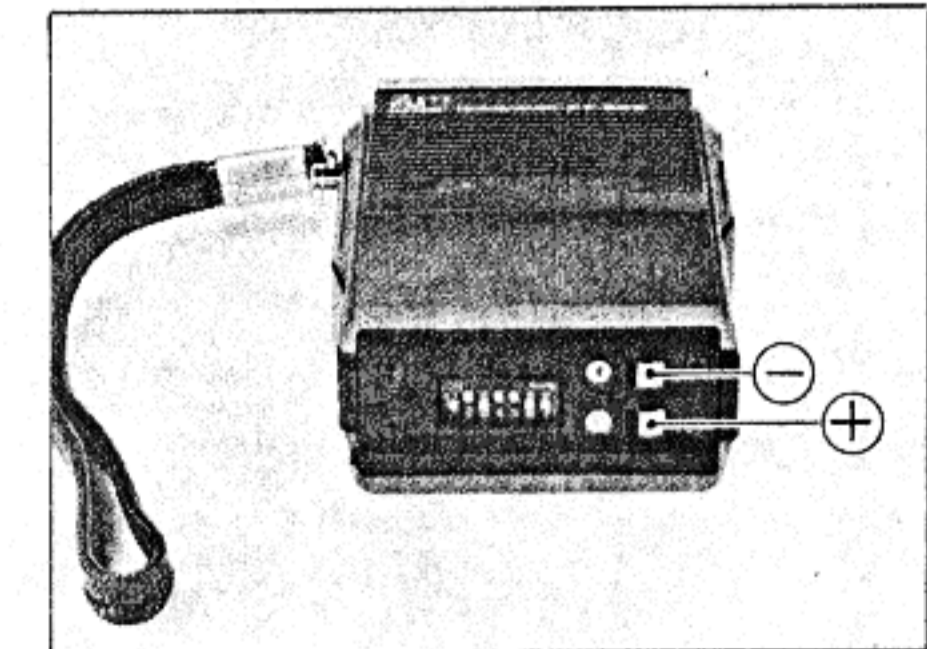
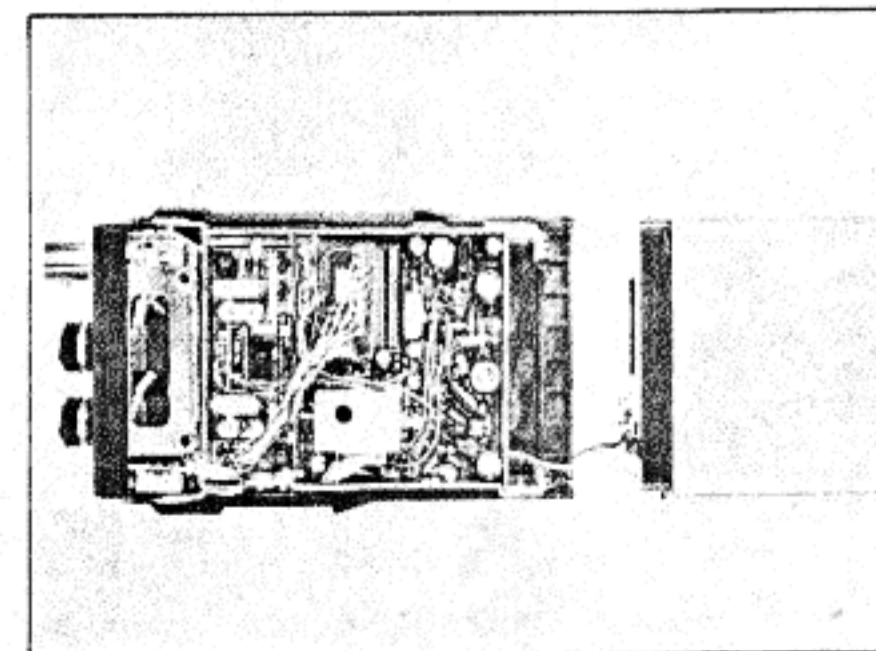

# CHASSIS DISASSEMBLY

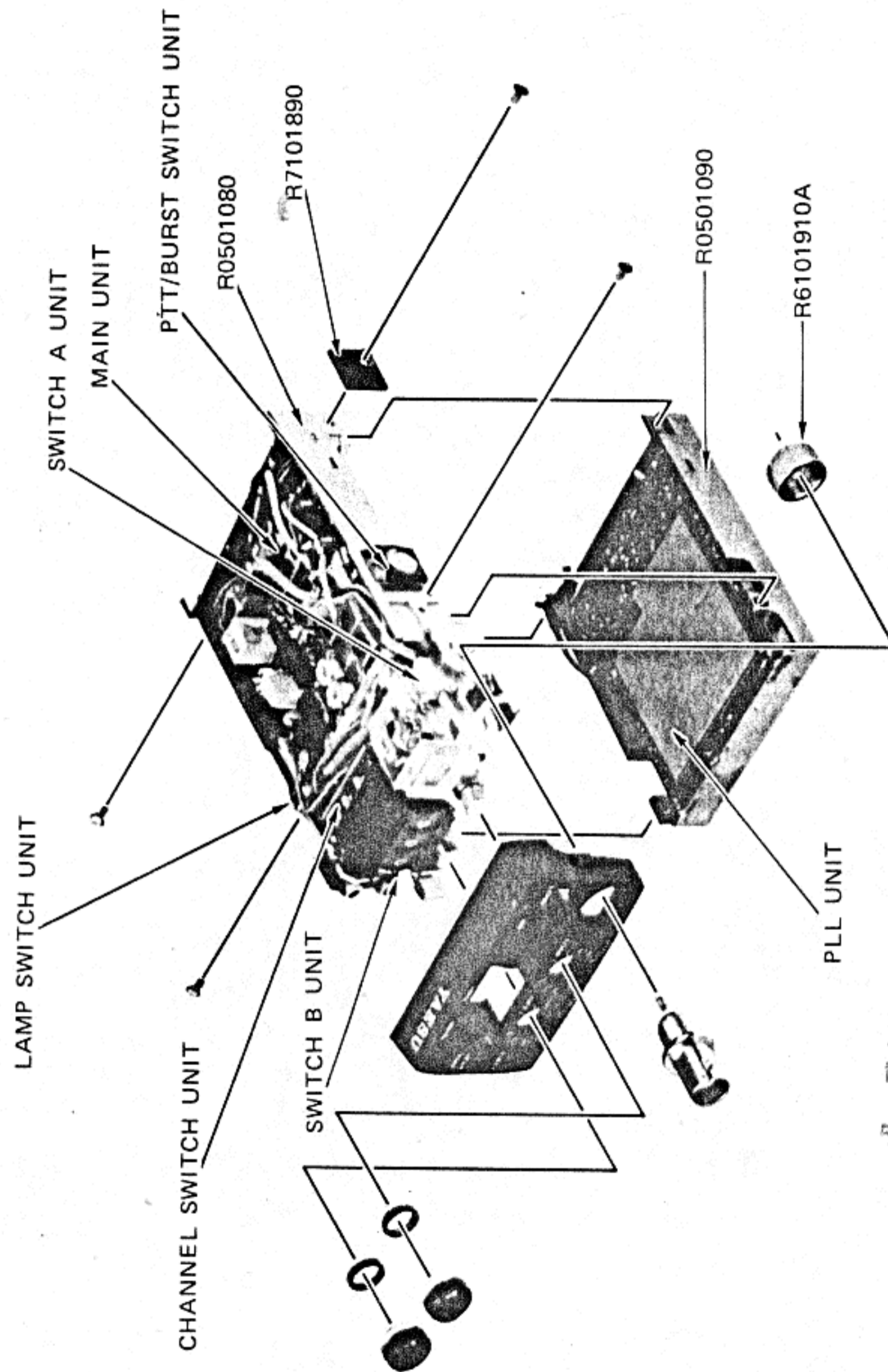

SCHEMATHEEK  
Beh. T. Hultermans  
Postbus 4228  
5604 EE Eindhoven

# PARTS LIST

MAIN CHASSIS			
Symbol No.	Part No.	Description	
*** PTT/BURST SWITCH UNIT ***			
	F2583000	Printed Circuit Board without S6 or S6 and S7	
SWITCHES			
S6	N4090040	KHG10901	(PTT)
S7	N4090040	"	(BURST) Models D and E
*** LAMP SWITCH UNIT ***			
	F2584000	Printed Circuit Board	
	C025840A	PCB with Components without S2	
TRANSISTOR			
Q1	G3413660A	2SD1366(AB)	
RESISTOR			
R2	J24205562	Chip RMC 1/10T 562J	5.6kΩ
SWITCH			
S2	N4090040	KHG10901	(LAMP)
*** CHANNEL SWITCH UNIT ***			
	F2585101	Printed Circuit Board	
	C025851A	PCB with Components	Models A and E
	C025851B	"	Model D
	C025851D	"	Model F
DIODES			
D1-4	G2090277	Si	1SS205 Model F
THUMBWHEEL SWITCHES			
S3,4,5	N7090029	A7MA-146-P2	(Frequency Select)

*** CONNECTION BOARD ***				
	F2585102	Printed Circuit Board		
	C025852A	PCB with Components	Models A and E	
	C025852B	"	Model D	
	C025852C	" (Q2,D5,6)	Model F	
<b>TRANSISTOR</b>				
Q2	G3327850E	2SC2785E	Model F	
<b>DIODES</b>				
D5,6	G2090027	Si 1SS53	Model F	
* * * * *				
<b>RESISTORS</b>				
R1	J20336390	Metallic film	2W	39 $\Omega$
R3	J01215562	Carbon film	1/8W	5.6k $\Omega$ TJ Model F
R4	J01215473	" "	"	47k $\Omega$ TJ "
R5	J01215221	" "	"	220 $\Omega$ TJ
<b>POTENTIOMETERS</b>				
VR1	J60800104	K09111002-5R1112-5KB	5k $\Omega$ B (SQL)	
VR2 (with S1)	J60800105	K09111008-5M1111-20KA	20k $\Omega$ A (VOL)	
<b>CAPACITORS</b>				
C2	K02175180	Ceramic disc	50WV	18pF CH
		(DD104CH180J50V)		
C1,3	K12171102	" "	"	0.001 $\mu$ F E
		(DD104E102P50V)		
<b>INDUCTOR</b>				
L1	L0020334			
<b>METER</b>				
M1	M0290044	MH-42F		
<b>MICROPHONE</b>				
MIC1	M3290007	EM-78		
<b>SPEAKER</b>				
SPI	M4090063	C035A13		

		<b>SWITCH</b>		
S1 (with VR2)	-	(POWER)		
S8 (with VR1)	-	(TSQ)		
		<b>ANTENNA JACK</b>		
J1	P1090353	BNC-RM		
		<b>LAMP</b>		
PL1	Q1000054	No 7656	6V	35mA
		<b>CONNECTORS</b>		
P1 (with wire)	T9204787A	for Tone Squelch	Models A and F	
P1 ( " )	T9204786B	for Tone Burst	Models D and E	
		R3501110 Control Panel w/r and g filters Models A, D and E		
		R3501120 " " " Model F		
		R3501070 Battery Mounting Track w/contacts		
		R3501140A Front Cover w/trim band, w/o spkr, mic Models A, D and E		
		R3501150 " " " " Model F		
		R3800510 Rear Cover w/o switch label, belt clip		
		R8101970A Switch Label (+600kHz RPT and VOX) Models A, D and E		
		R8102040A " " (VOX) Model F		
		R3501040 Left Side Cover (PTT) or (PTT and BURST)		
		R3501060 Right Side Cover (LAMP)		



R1020,1043	J24205473	Chip RMC 1/10T 473J 1/10W 47k $\Omega$		
R1012	J24205823	" " " 823J " 82k $\Omega$		
R1005-1007, 1015,1016,1018, 1047,1049	J24205104	" " " 104J " 100k $\Omega$		
R1024	J24205274	" " " 274J " 270k $\Omega$		
R1030,1033	J24205564	" " " 564J " 560k $\Omega$		
		<b>POTENTIOMETERS</b>		
VR1002	J51745103	H0651A013-10KB	10k $\Omega$ B	
VR1001	J51745104	H0651A019-100KB	100k $\Omega$ B	
VR1003	J51759204	PD6P-204	200k $\Omega$ B	
		<b>CAPACITORS</b>		
C1107	K00173100	Ceramic disc (DD104SL100D50V)	50WV 10pF	SL
C1011,1021,1065, 1095	K22170502	Chip (C2012RH1H010C)	" 1pF	RH
C1016	K22170503	" (C2012RH1H020C)	" 2pF	"
C1025,1088,1093	K22170504	" (C2012RH1H030C)	" 3pF	"
C1027,1096	K22170506	" (C2012RH1H050C)	" 5pF	"
C1004,1008,1012	K22170306	" (C2012UJ1H050C)	" 5pF	UJ
C1018,1022	K22170307	" (C2012UJ1H060D)	" 6pF	"
C1062,1066	K22170308	" (C2012UJ1H070D)	" 7pF	"
C1069	K22170508	" (C2012RH1H070D)	" 7pF	RH
C1071,1075	K22170509	" (C2012RH1H080D)	" 8pF	"
C1003,1102	K22170511	" (C2012RH1H100D)	" 10pF	"
C1064	K22170313	" (C2012UJ1H120D)	" 12pF	UJ
C1067	K22170315	" (C2012UJ1H150J)	" 15pF	"
C1080	K22170515	" (C2012RH1H150J)	" 15pF	RH
C1002,1089	K22170517	" (C2012RH1H180J)	" 18pF	"

C1001,1087	K22170519	Chip (C2012RH1H220J)	50WV 22pF	RH
C1006,1009,1013	K22170319	" (C2012UJ1H220J)	" 22pF	UJ
C1020,1023	K22170321	" (C2012UJ1H270J)	" 27pF	"
C1007	K22170521	" (C2012RH1H270J)	" 27pF	RH
C1092,1100	K22170523	" (C2012RH1H330J)	" 33pF	"
C1094	K22170525	" (C2012RH1H390J)	" 39pF	"
C1068,1076,1081	K22170527	" (C2012RH1H470J)	" 47pF	"
C1086	K22170533	" (C2012RH1H820J)	" 82pF	"
C1030,1089,1039	K22170539	" (C2012RH1H151J)	" 15pF	"
C1005,1014,1017, 1019,1024,1032, 1033,1035,1045, 1049,1057,1059, 1061,1063,1070, 1072,1073,1074, 1077,1078,1082, 1083,1085,1090, 1091, 1097-1099, 1101,1104,1105, 1106	K22170901	" (C2012D1H102M)	" 0.001 $\mu$ F	D
C1046	K22170817	" (C2012B1H103Z)	" 0.01 $\mu$ F	B
C1026,1028,1044	K22171004	" (C2012F1H103Z)	" 0.01 $\mu$ F	F
C1015,1041,1042	K22171008	" (C2012F1H473Z)	" 0.047 $\mu$ F	F
C1029,1034,1047, 1050,1054,1055	K22141904	" (C3216D1E104M)	25WV 0.1 $\mu$ F	D
C1031	K70167224	Tantalum (CS15E1VR22M)	35WV 0.22 $\mu$ F	
C1079,1084,1103	K70120002	" (489D106X0016C1)	16WV 10 $\mu$ F	
C1040	K70080006	" (489D476X0006D1)	6.3WV 47 $\mu$ F	
C1060	K40179001	" (ECE-A1HK010)	50WV 1 $\mu$ F	
C1036	K40129015	Electrolytic (ECE-A1CK4R7)	16WV 4.7 $\mu$ F	
C1043,1051	K40129012	" (ECE-A1CK100)	" 10 $\mu$ F	

C1053,1056,1058	K40109015	Electrolytic (ECE-A1AK101)	10WV	100 $\mu$ F
		<b>TRIMMER CAPACITOR</b>		
TC101	K9100100	ECR-GA020E30	20pF	
		<b>TRANSFORMERS</b>		
T1001	L0021416			
T1002	L0021417			
T1003,1004,1006, 1007,1010-1012	L0021418			
T1005,1008,1009	L0021419			
		<b>INDUCTORS</b>		
L1001,1004	L1020686			
L1002,1005,1009, 1015,1016	L1020677			
L1003	L0020748			
L1007	L0021261			
L1008	L0020726			
L1010	L0020987A			
L1011,1014	L0020342			
L1012	L1190105	FL3H-1R0M		
L1013	L1020687			
	R0103620	HEAT SINK		
<b>PLL UNIT</b>				
Symbol No.	Part No.	Description		
	F2575102	Printed Circuit Board		
		PCB with Components		
	C025752A	"	Models A and E	
	C025752C	"	Model D	
	C025752D	"	" E	
	C025751D	"	" F	

		<b>ICs</b>			
Q2007	G1090247	TC9122P			
Q2008	G1090560	TC5082PL			
Q2009	G1090473	TC5081AP			
Q2012	G1090559	LA6324M			
		<b>FETS</b>			
Q2001	G3802107Y	2SK210Y(YY)			
Q2017	G3802087O	2SK208-O(JO)			
		<b>TRANSISTORS</b>			
Q2010,2013,2015, 2020-2022,2025	G3111627G	2SA1162GR(SG)			
Q2016	G3207930R	2SB793R			
Q2002-2006	G3326207B	2SC2620B(QB)			
Q2011,2014,2018, 2019,2023,2024, 2026,2027	G3327127G	2SC2712GR(LG)			
		<b>DIODES</b>			
D2012,2013,2016	G2070009	Si	1SS184(B3)		
D2002-2011, 2014,2017	G2090277	"	1SS205		
D2001	G2090180	Varactor	FC53M-5		
D2015	G2090176	Zener	HZ6A1L		
		<b>CRYSTALS</b>			
X2001	H0102560	HC-18/T	59.655MHz	Models A, D and E	
X2001	H0102564A	"	32.32625MHz	Model F	
X2002	H0102563	"	64.7025MHz	Models A, D and E	
X2003	H0102561	"	65.0025MHz	"	
X2003	H0102565A	"	35.000MHz	Model F)	
X2004	H0102562	"	65.3025MHz	Models A, D and E	
X2005	H0102559	"	5.1205MHz		
		<b>RESISTORS</b>			
R2084	J10216221	Carbon composition	1/8W	220 $\Omega$	GK
R2049	J10216102	"	"	1k $\Omega$	"
R2036,2076,2081, 2082	J24205000	Chip RMC 1/10T 000J	1/10W	0 $\Omega$	

R2075,2083	J24205470	Chip RMC 1/10T 470J 1/10W 47Ω
R2011,2073,2074, 2077,2010 (A,D,E)	J24205101	" " " 101J " 100Ω
R2003,2030	J24205221	" " " 221J " 220Ω
R2041	J24205331	" " " 331J " 330Ω
R2004,2023,2080	J24205471	" " " 471J " 470Ω
R2010(F)	J24205561	" " " 561J " 560Ω
R2062,2078	J24205102	" " " 102J " 1kΩ
R2059,2072	J24205 52	" " " 152J " 1.5kΩ
R2007,2014,2016, 2018,2020,2025, 2029,2037	J24205222	" " " 222J " 2.2kΩ
R2050	J24205272	" " " 272J " 2.7kΩ
R2060	J24205332	" " " 332J " 3.3kΩ
R2013,2015,2017, 2019,2067	J24205472	" " " 472J " 4.7kΩ
R2064	J24205562	" " " 562J " 5.6kΩ
R2012	J24205682	" " " 682J " 6.8kΩ
R2021	J24205822	" " " 822J " 8.2kΩ
R2022,2032,2040, 2055,2057,2058, 2061,2063,2066, 2068,2070,2071	J24205103	" " " 103J " 10kΩ
R2044	J24205153	" " " 153J " 15kΩ
R2047,2048	J24205183	" " " 183J " 18kΩ
R2001,2002,2008, 2038,2046,2065	J24205223	" " " 223J " 22kΩ
R2005,2042	J24205333	" " " 333J " 33kΩ
R2009,2034,2035, 2039,2056,2079, 2086(A,D,E)	J24205473	" " " 473J " 47kΩ
R2053	J24205683	" " " 683J " 68kΩ
R2006,2014, 2026-2028, 2031,2033,2051, 2069	J24205104	" " " 104J " 100kΩ
R2043,2052	J24205124	" " " 124J " 120kΩ
R2045	J24205105	" " " 105J " 1MΩ
R2054	J24205225	" " " 225J " 2.2MΩ
		POTENTIOMETER
VR2001	J51745472	H0651A011-4.7KB 4.7kΩ

		CAPACITORS			
C2011	K22170502	Chip (C2012RH1H010C)	50WV	1pF	RH
C2013	K22170503	" (C2012RH1H020C)	"	2pF	"
C2010	K22170511	" (C2012RH1H100D)	"	10pF	"
C2016	K22170311	" (C2012UJ1H100D)	"	10pF	UJ
C2008	K22170211	" (C2012CH1H100D)	"	10pF	CH
C2032	K22170515	" (C2012RH1H150D)	"	15pF	RH
C2021,2022,2023, 2024	K22170319	" (C2012UJ1H1220J)	"	22pF	UJ
C2003,2009	K22170223	" (C2012CH1H330J)	"	33pF	CH
C2033,2034	K22170523	" (C2012RH1H330J)	"	33pF	RH
C2017,2026	K22170527	" (C2012RH1H470J)	"	47pF	"
C2014	K22170327	" (C2012UJ1H470J)	"	47pF	UJ
C2027,2097	K22170529	" (C2012RH1H560J)	"	56pF	RH
C2002,2007,2020, 2028,2029,2041	K22170801	" (C2012B1H471M)	"	470pF	B
C2025,2046	K22170805	" (C2012B1H102M)	"	0.001μF	B
C2004,2006,2037, 2040,2051,2052, 2054-2056, 2060,2064,2065, 2068,2069,2074, 2076,2080-2093 2098,2100	K22170901	" (C2012D1H102M)	"	0.001μF	D
C2045	K22170806	" (C2012B1H122M)	"	0.0012μF	B
C2047	K22170813	" (C2012B1H472M)	"	0.0047μF	B
C2036	K22170817	" (C2012B1H103Z)	"	0.01μF	B
C2012,2015,2018, 2019,2030,2050, 2079,2096	K22171004	" (C2012F1H103Z)	"	0.01μF	F
C2058	K22171008	" (C2012F1H473Z)	"	0.047μF	F
C2031	K22141904	" (C3216D1E104M)	25WV	0.1μF	D



C2099	K10186102	Ceramic disc (RD870-1B102K63V)	63WV	0.001 $\mu$ F	B
C2043,2044	K70167104	Tantalum (CS15E1V0R1M)	35WV	0.1 $\mu$ F	
C2039	K70140007	" (489D105X0025A1)	25WV	1 $\mu$ F	
C2057	K70127225	" (CS15E1C2R2M)	16WV	2.2 $\mu$ F	
C2005,2095	K70107335	" (CS15E1A3R3M)	10WV	3.3 $\mu$ F	
C2035	K70120001	" (489D475X0016B1)	16WV	4.7 $\mu$ F	
C2049	K40179002	Electrolytic (ECE-A1HK0R1)	50WV	0.1 $\mu$ F	
C2048,2059,2075	K40179001	" (ECE-A1HK010)	"	1 $\mu$ F	
C2038,2066,2072, 2094,2035*	K40129012	" (ECE-A1CK100)	16WV	10 $\mu$ F	
C2063	K40129028	" (ECE-A1CK470)	"	47 $\mu$ F	
C2053	K40089007	" (ECE-A0JK101)	6.3WV	100 $\mu$ F	
* Model F					
<b>TRANSFORMER</b>					
T2001	L0021418				
<b>INDUCTORS</b>					
L2001,2002	L1190146	FL3H-8R2M	8.2 $\mu$ H		
L2004,2005	L1190145	FL3H-1R8M	1.8 $\mu$ H		
L2015	L1190141	FL3H-100K	10 $\mu$ H		
L2016	L1190110	FL3H-4R7K	4.7 $\mu$ H		
L2003	L0021415				
L2007,2009,2010, 2011,2013,2014	L0021420				(Models A, D and E)
L2008*,2012*	L0021434				(Model F)
<b>CONNECTORS</b>					
J2001	P0090390	3022-07A			
J2002	P0090069	3022-06A			
<b>SWITCHES</b>					
S2001	N6090042	SSS313040			(Models A, D and E)
S2002	N6090040	SSS323122			

	R0102660	Shield Case			
	R0102670	Shield Cover			
	R0103360A	Shield Plate			
<b>SWITCH UNIT A</b>					
Symbol No.	Part No.	Description			
	F2576101	Printed Circuit Board			
	C025761A	PCB with Components			
<b>LEDS</b>					
D3001	G2090278	LN38GCP			
D3002	G2090279	LN28RCP			
<b>SWITCH</b>					
S3001	N4090088	SPJ622N			(HI/LOW)
<b>SWITCH UNIT B</b>					
Symbol No.	Part No.	Description			
	F2576102	Printed Circuit Board			
	C025762A	PCB with Components Models A, D and E			
	C025762B	" Model F			
<b>SWITCH</b>					
S4001	N4090088	SPJ622N			(CALL)
<b>JACKS</b>					
J4001	P1090369	HSJ0838-01-010			(EXT MIC)
J4002	P1090370	HSJ0836-01-010			(EXT EAR)
<b>ACCESSORIES</b>					
Symbol No.	Part No.	Description			
		Antenna			
	Q3000037	YHA-14A			
		Ni-Cd Battery Pack*			
	D3000315	FNB-3			
		Dry Battery Case*			
	D3000317	FBA-5			
	R0101840	Belt Clip (attached)			
	S6000061	Hand Strap ( " )			
* Optional some models					

TONE BURST UNIT: (Models D and E)					
Symbol No.	Part No.	Description			
	F2577000	Printed Circuit Board			
		PCB with Components			
	C025770A	1750Hz Tone Model			
	C025770B	1800Hz Tone Model			
		IC			
Q5001	G1097239	TC5082P			
		CRYSTALS			
X5001	H0101983	HC-18/T	7.3728MHz (1800Hz Tone)		
X5001	H0101982	HC-18/T	7.168MHz (1750Hz Tone)		
		RESISTORS			
R5003	J00215683	Carbon film	1/8W	68k $\Omega$	TJ
R5002	J01215154	" "	"	150k $\Omega$	TJ
R5001	J00215474	" "	"	470k $\Omega$	VJ
		CAPACITORS			
C5001	K00175150	Ceramic disc	50WV	15pF	SL
		(DD104SL150J50V)			
C5002	K00175330	" "	"	33pF	"
		(DD104SL330J50V)			
C5006	K12171102	" "	"	0.001 $\mu$ F	E
		(DD104E102P50V)			
C5005	K14180103	" "	63WV	0.01 $\mu$ F	FZ
		(RD871-1FZ103Z63V)			
		SIP CONNECTOR			
T5001	P0090373	5703-06CPB			

FTS-7 TONE ENCODER/DECODER (D3000321)					
Symbol No.	Part No.	Description			
	F2578101	Printed Circuit Board			
		IC			
Q1001	G1090577	MN6520			
		DIODES			
D1001,1002	G2090244	Schottky Barrier	ISS106		
		CRYSTAL			
X1001	H0102571	MS-309	4.194304MHz		
		RESISTORS			
R1009,1010	J24205102	Chip RMC 1/10T	1k $\Omega$		
R1002	J24205222	" "	2.2k $\Omega$		
R1006	J24205472	" "	4.7k $\Omega$		
R1003,1007,1008	J24205103	" "	10k $\Omega$		
R1004,1005	J24205123	" "	12k $\Omega$		
R1001	J24205104	" "	100k $\Omega$		
		POTENTIOMETER			
VR1001	J51750473	H0423A	47KB	47k $\Omega$ B	
		CAPACITOR			
C1008,1009	K22170517	Chip Ceramic	50WV	18pF	RH
		(C2012RH1H180J)			
C1005	K22171004	" "	"	0.01 $\mu$ F	F
		(C2012F1H103Z)			
C1002,1004	K22141904	" "	25WV	0.1 $\mu$ F	D
		(C3216D1E104M)			
C1003	K72080002	Chip Tantalum	6.3WV	4.7 $\mu$ F	
		(F950J475MA1)			
C1001,1006	K72080003	" "	"	10 $\mu$ F	
		(F950J106MC1)			
C1007	K72060007	" "	4WV	100 $\mu$ F	
		(F950G107MH1)			
		SWITCH			
S1001	N7090030	SGK1072			
		CONNECTOR			
J1001	P0090373	5703-06CPB			

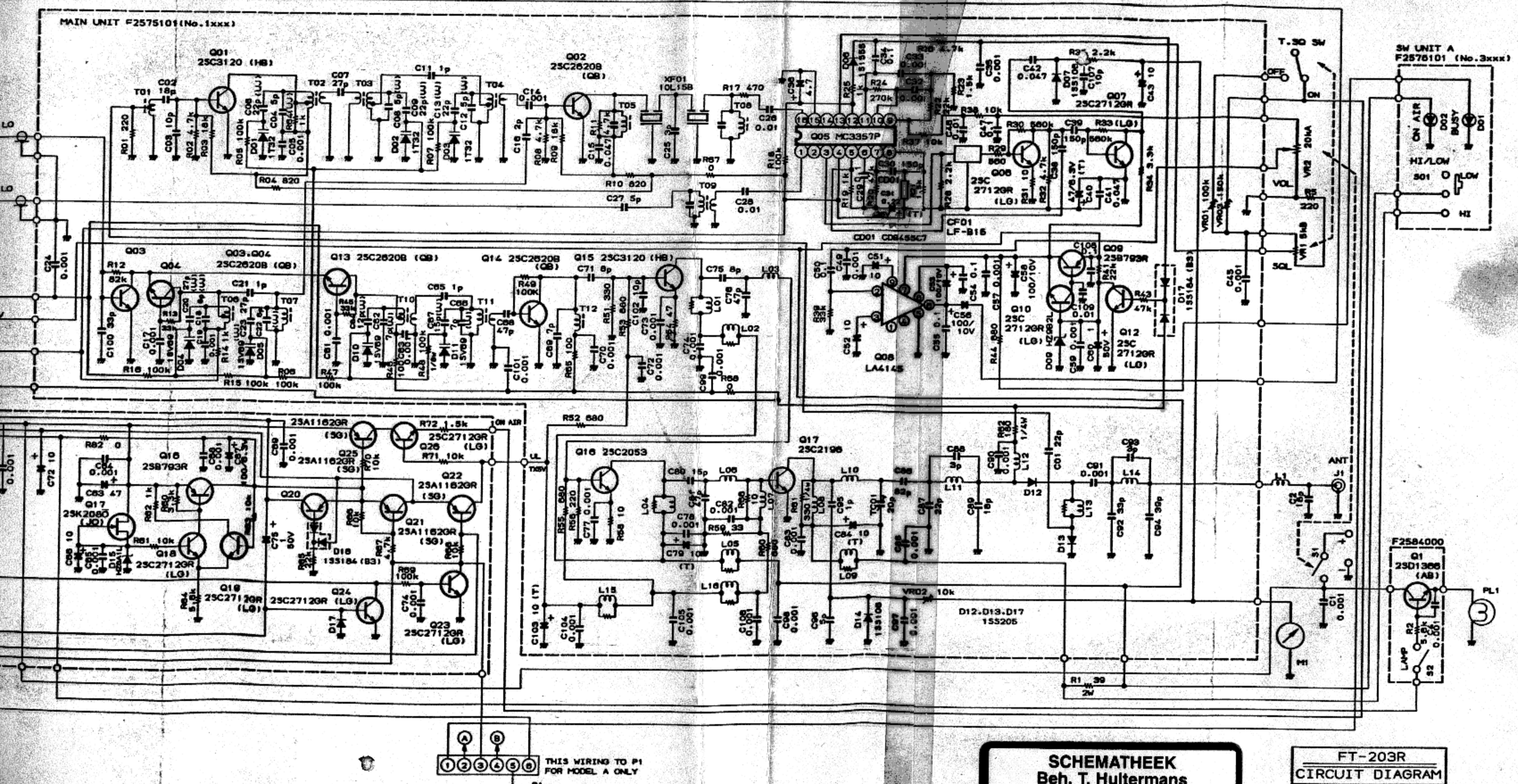

1 2 3 4 5 6 7 8 9 THIS WIRING TO P1 FOR MODEL A ONLY

**SCHEMATEEK**  
 Beh. T. Hultermans  
 Postbus 4228  
 5604 EE Eindhoven

FT-203R  
 CIRCUIT DIAGRAM  
 MODEL A.D.E

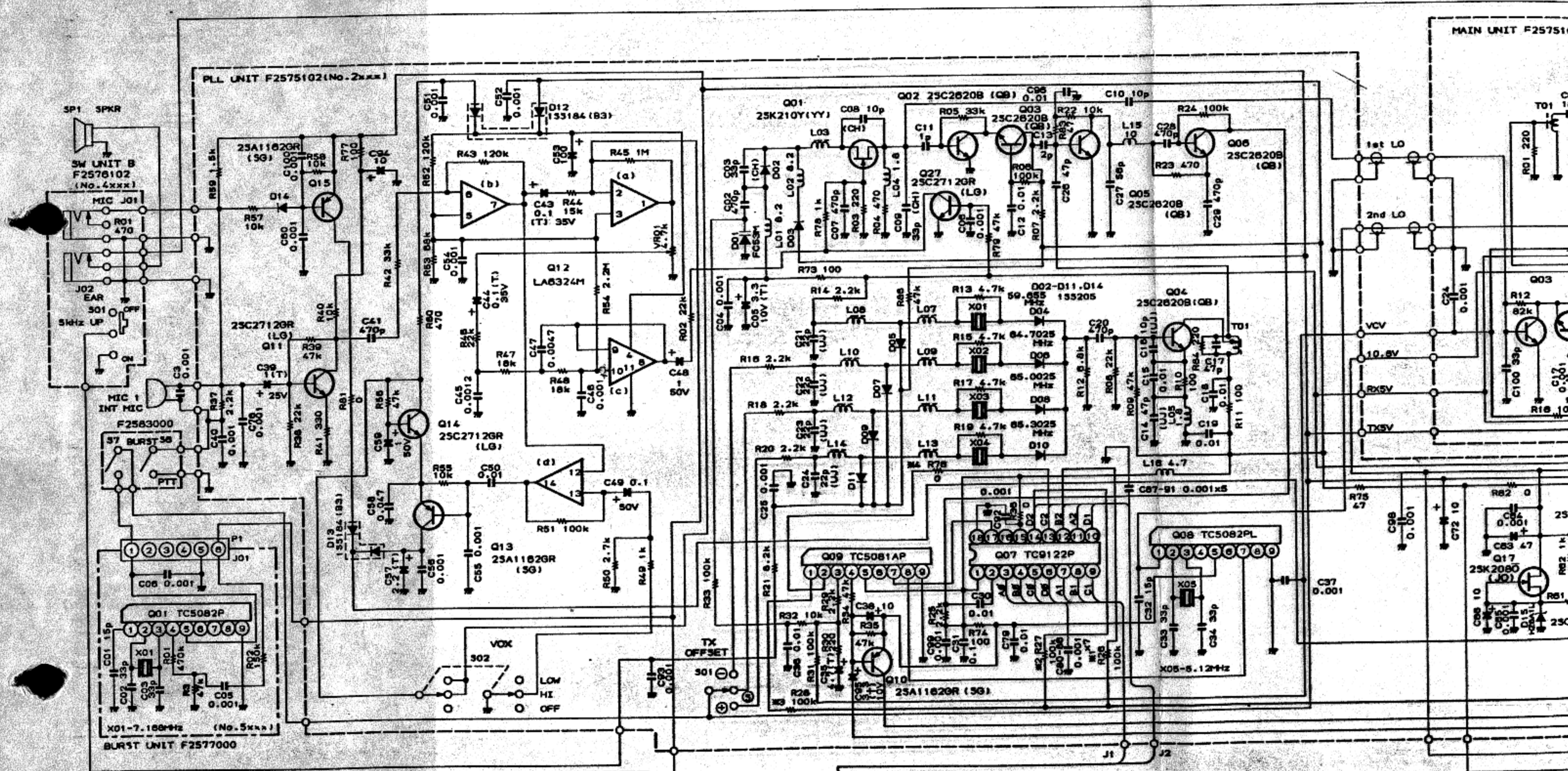

37 (BURST SW) AND BURST UNIT FOR MODELS D AND E

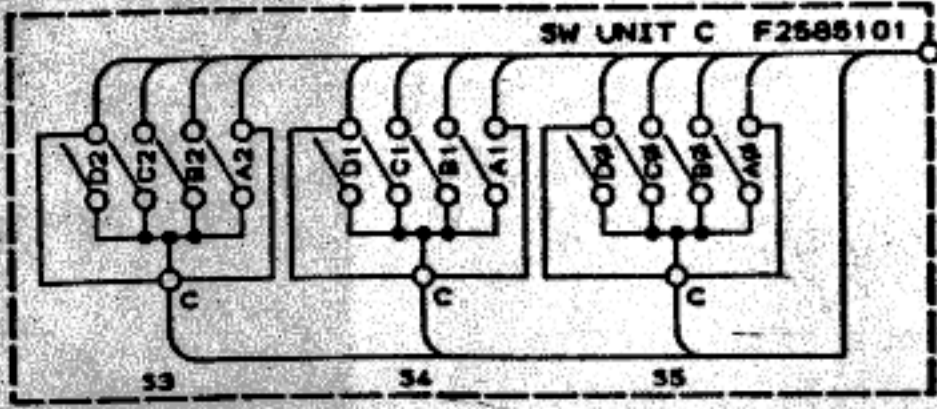

	A	D	E
1	N	Y	N
2	N	Y	N
3	Y	Y	Y